

# CONTRACT

---



## **BETWEEN THE CITY OF MOORE, OKLAHOMA AND MATTHEWS TRENCHING COMPANY, INC. FOR LITTLE RIVER PARK SANITARY SEWER INTERCEPTOR REHABILITATION/REPLACEMENT**

### **Preamble**

This Contract is entered into between the City of Moore, Oklahoma (“the City”), a municipality, with principal offices at 301 N. Broadway, Moore, Oklahoma 73160 and Matthews Trenching Company, Inc. with principal offices at 919 S Fairmont Ave, Oklahoma City, Oklahoma 73129

WHEREAS, the City requires the services of Matthews Trenching Company, Inc. (“the Contractor”) to complete the Little River Park Sanitary Sewer Interceptor Rehabilitation/Replacement, Project #I-03-W-LMA, not to exceed \$1,274,018.75;

WHEREAS, the Contractor has agreed to provide said services, to the extent outlined herein;

NOW THEREFORE, in consideration of the premises and conditions set forth below the party’s contract;

## **Section 1: Term and Termination**

- 1) The term of the contract shall be from April 3, 2017 through April 3, 2018;
- 2) The Contract may be terminated in whole or in part as follows:
  - (1) By the City of Moore, if a Contractor fails to comply with the terms and conditions of a Federal award;
  - (2) By the City of Moore for cause;
  - (3) By the City of Moore with the consent of the Contractor, in which case the two parties must agree upon the termination conditions, including the effective date and, in the case of partial termination, the portion to be terminated; or
  - (4) By the Contractor upon sending to the City of Moore written notification setting forth the reasons for such termination, the effective date, and, in the case of partial termination, the portion to be terminated. However, if the City of Moore or HUD determines in the case of partial termination that the reduced or modified portion of the Federal award or sub-award will not accomplish the purposes for which the Federal award was made, the City of Moore may terminate the Federal award in its entirety.

(c) When a Federal award is terminated or partially terminated, the City of Moore and the Contractor remain responsible for compliance with the requirements in 2 CFR 200.343 Closeout and 2 CFR 200.344 Post-closeout adjustments and continuing responsibilities. References: (2 CFR 200.339; 78 FR 78608, Dec. 26, 2013, as amended at 80 FR 43309, July 22, 2015)
- 3) The Contract may be amended as provided for in Section 8: Modification or Amendment

## **Section 2: Scope of Services**

The work will consist of the construction of the Sanitary Sewer Interceptor Rehabilitation/Replacement at the Little River Park, Moore, Oklahoma.

This project will be federally funded by the U.S. Department of Housing and Urban Development (HUD) and will adhere to federal regulations. The Contractor will provide all necessary construction crews with adequate staffing to complete assigned projects. All equipment shall be provided to complete the assigned construction project or construction task. This equipment shall all be in good operating condition. The contractor shall also provide its own tools, fuel, safety equipment, communications equipment, and manually operated tools, local or mobile field office, and office equipment.

All work and materials will comply with the current version of the City of Oklahoma City Standard Specification for the Construction of Public Improvements with all amendments and revisions included (hereafter referred to as "standard specifications") and the City of Oklahoma City Construction Standard Details (hereafter referred to as "standard details"). When these standard specifications and standard details do not address certain construction tasks or certain required construction materials, then the Oklahoma Department of Transportation Standard Specifications for Highway Construction will govern.

**PAY ITEM NOTES:**

Cost to include all sod required to repair all disturbed areas. Replacement sod shall be like kind (Bermuda or fescue) of existing conditions.

All point repairs will include necessary pipe, fittings, appurtenances, excavation and backfill required to repair broken sewer line that cannot be repaired by trenchless rehabilitation.

Pre-construction television inspection shall be completed for the entire project length prior to any construction activities.

Contractor shall conduct video inspection prior to construction and post construction for all pipe to be rehabilitated. Three copies of post construction video shall be provided to the owner.

Contractor to reconnect all existing sanitary sewer connections and provide all necessary HDPE or PCV (SDR 26) piping to complete the connection.

Contractor to rehabilitate manholes as designated on the drawings. Rehabilitation method shall use a cementitious material and applied to a thickness of 1/2 inch. Strong Seal MS-2C or approved equal.

All flow control equipment, hoses, and other devices shall be free of any leaks, and inspected daily for the presence of new leaks. Leaking equipment shall be repaired or replaced immediately.

Traffic control plans must be submitted to the City of Moore Traffic Engineer for approval prior to any lane or street closures. Notice of lane or street closures must be provided to the City of Moore one (1) week prior to closure.

All signs, barricades, warning lights and other traffic control devices used for construction traffic control shall meet the requirements of the latest edition of the manual on Uniform Traffic Control Devices for Streets and Highways as pertains to shape, size, color, mounting height, and placement.

#### **GENERAL CONSTRUCTION NOTES:**

All work performed and materials supplied shall conform to the plans and/or project specifications. Any work not covered in the plans or specifications shall conform to the City of Moore's "Standard Specifications and Construction Drawings" or the "Standard Specifications for Highway Construction, Oklahoma Department of Transportation, Edition of 2009" and "Supplementals".

The contractor shall be responsible for notifying all utility companies and governmental agencies who might have utility lines on or about the premises, or who might be affected by the construction. The contractor shall also coordinate their activities with the utility companies to ensure compliance with the project schedule. The contractor shall make every effort to protect existing utility lines, and shall repair any damages at their own expense.

Unless otherwise specified, the contractor shall be responsible for their own construction staking.

The contractor shall be responsible for erecting and maintaining barricades and other traffic warning devices as necessary around the perimeter of construction and adjacent to any open trenches.

All valve boxes, manhole lids, and sewer clean-outs located in paved areas, shall be H-20 traffic rated.



The contractor shall be responsible for verifying elevations and adjusting all covers and lids in paved areas to finished grade. All field adjustments shall be noted and brought to the engineer's attention for approval.

Contractor shall field verify and report to the engineer all existing utilities elevations that cross or conflict with proposed construction prior to beginning any work.

Contact utility providers and owner 48 hours prior to connection to existing utility lines.

Contractor shall solely be responsible for all required trench shoring.

Contractor shall also act in accordance to Addendum 1 and 2 of RFP #1607-03, located in Appendix E, and The Little River Park Sanitary Sewer Interceptor Rehabilitation/Replacement engineering plans completed by Cabbiness Engineering, located in Appendix D.

## **Section 3: General Terms and Conditions**

### **Laws and Regulations**

The Community Development Block Grant – Disaster Recovery (CDBG-DR) allocation to the City of Moore is governed by the following laws and regulations:

- (a) The Housing and Community Development Act of 1974;
- (b) Section 312 of the Robert T. Stafford Disaster Relief and Emergency Assistance Act (42 U.S.C.5155), as amended;
- (c) Section 18 of the Small Business Act, as amended (14A U.S.C. 647) 44 CFR 206.191 Duplication of Benefit
- (d) Duplication of Benefits Federal Register, Vol. 76, No.221, November 16, 2011 (76 FR 71060) Public Law 113-2:
- (e) Disaster Relief Appropriations Act, 2013 (at HR 152-34)
- (f) The HUD Federal Register Notice at 78 FR 14329 published March 5, 2013
- (g) HUD Federal Register Notice at 78 FR 23578 published April 19, 2013
- (h) HUD Federal Register Notice at 78 FR 76154 published December 16, 2013

- (i) The applicable laws of the State of Oklahoma; and
- (j) By the laws and regulations promulgated by the City for the CDBG-DR program.
- (k) In addition to the citations noted, the CDBG-DR allocation is also subject to “cross-cutting” Federal requirements referenced herein and contained in 2 CFR 200 Sub-part F – Appendix

### **Federal Changes**

Contractor shall at all times comply with all applicable Federal regulations, policies, procedures and directives, including without limitation those listed directly or by reference in this Contract between the City of Moore Department of Capital Planning and Resiliency and the Contractor, as such Federal regulations, policies, procedures and directives may be amended or promulgated from time to time during the term of this contract. Contractor’s failure to so comply shall constitute a material breach of this contract. Reference: (49 CFR Part 18)

### **Compliance with the Copeland “Anti-Kickback” Act**

1.) Whoever, by force, intimidation, or threat of procuring dismissal from employment, or by any other manner whatsoever induces any person employed in the construction, prosecution, completion or repair of any public building, public work, or building or work financed in whole or in part by loans or grants from the United States, to give up any part of the compensation to which he is entitled under his contract of employment, shall be fined under this title or imprisoned not more than five years, or both.

1.) In General.—The Secretary of Labor shall prescribe reasonable regulations for contractors and subcontractors engaged in constructing, carrying out, completing, or repairing public buildings, public works, or buildings or works that at least partly are financed by a loan or grant from the Federal Government. The regulations shall include a provision that each contractor and subcontractor each week must furnish a statement on the wages paid each employee during the prior week. References: (18 U.S.C. 874) as supplemented in Department of Labor regulations (29 CFR part 3).

### **Compliance with the Davis-Bacon Act**

1.) The contractor or subcontractor shall pay all mechanics and laborers employed directly on the site of the work, unconditionally and at least once a week, and without subsequent deduction or rebate on any account, the full amounts accrued at time of payment, computed at wage rates not less than those stated in the advertised specifications, regardless of any contractual relationship which may be alleged to exist between the contractor or subcontractor and the laborers and mechanics;

2.) The contractor will post the scale of wages to be paid in a prominent and easily accessible place at the site of the work; and

3.) There may be withheld from the contractor so much of accrued payments as the contracting officer considers necessary to pay to laborers and mechanics employed by the contractor or any subcontractor on the work the difference between the rates of wages required by the contract to be paid laborers and mechanics on the work and the rates of wages received by the laborers and mechanics and not refunded to the contractor or subcontractors or their agents. References: (40 U.S.C. 276a to 276a-7) as supplemented by Department of Labor regulations (29 CFR part 5).

### **Compliance with Sections 103 and 107 of the Contract Work Hours and Safety Standards Act.**

1.) The Contract Work Hours and Safety Standards Act requires that laborers or mechanics shall be paid wages at a rate not less than one and one-half times the basic rate of pay for all hours worked in excess of forty hours in any workweek. In the event of violation of this provision, the contractor and any subcontractor shall be liable for the unpaid wages and in addition for liquidated damages, computed with respect to each laborer or mechanic employed in violation of the Act in the amount of \$25 for each calendar day in the workweek on which such individual was required or permitted to work in excess of forty hours without payment of required overtime wages. Any contractor or subcontractor aggrieved by the withholding of liquidated damages shall have the right to appeal to the head of the agency of the United States (or the territory of District of Columbia, as appropriate) for which the contract work was performed or for which financial assistance was provided.

2.) *Findings and recommendations of the Agency Head.* The Agency Head has the authority to review the administrative determination of liquidated damages and to issue a final order affirming the determination. It is not necessary to seek the concurrence of the Administrator but the Administrator shall be advised of the action taken. Whenever the Agency Head finds that a sum of liquidated damages administratively determined to be due is incorrect or that the contractor or subcontractor violated inadvertently the provisions of the Act notwithstanding the exercise of due care upon the part of the contractor or subcontractor involved, and the amount of the liquidated damages computed for the contract is in excess of \$500, the Agency Head may make recommendations to the Secretary that an appropriate adjustment in liquidated damages be made or that the contractor or subcontractor be relieved of liability for such liquidated damages. Such findings with respect to liquidated damages shall include findings with respect to any wage underpayments for which the liquidated damages are determined.

3.) The recommendations of the Agency Head for adjustment or relief from liquidated damages under paragraph (a) of this section shall be reviewed by the Administrator or an authorized representative who shall issue an order concurring in the recommendations, partially concurring in the recommendations, or rejecting the recommendations, and the reasons therefor. The order shall be the final decision of the Department of Labor, unless a petition for review is filed pursuant to part 7 of this title, and the Administrative Review Board in its discretion reviews such decision and order; or, with respect to contracts subject to the Service Contract Act, unless petition for review is filed pursuant to part 8 of this title, and the Administrative Review Board in its discretion reviews such decision and order.

4.) Whenever the Agency Head finds that a sum of liquidated damages administratively determined to be due under section 104(a) of the Contract Work Hours and Safety Standards Act for a contract is \$500 or less and the Agency Head finds that the sum of liquidated damages is incorrect or that the contractor or subcontractor violated inadvertently the provisions of the Contract Work Hours and Safety Standards Act notwithstanding the exercise of due care upon the part of the contractor or subcontractor involved, an appropriate adjustment may be made in such liquidated damages or the contractor or subcontractor may be relieved of liability for such liquidated damages without

submitting recommendations to this effect or a report to the Department of Labor. This delegation of authority is made under section 105 of the Contract Work Hours and Safety Standards Act and has been found to be necessary and proper in the public interest to prevent undue hardship and to avoid serious impairment of the conduct of Government business. References: (40 U.S.C. 327–330) as supplemented by Department of Labor regulations (29 CFR part 5)

### **Assignability**

The Contractor shall not assign or transfer any interest in this Contract without the prior written consent of the City thereto; provided, however, that claims for money due or to become due to the contractors from the City under this contract may be assigned to a bank, trust company, or other financial institution without such approval. Notice of any such assignment or transfer shall be furnished promptly to the City.

### **Access to Records**

The Contractor agrees that the U.S. Department of Housing and Urban Development (“HUD”), the Inspectors General, the Comptroller General of the United States, and the City Moore, or any of their authorized representatives, have the right of access to any documents, papers, or other records of the Contractor which are pertinent to the Federal award, in order to make audits, examinations, excerpts, and transcripts. The right also includes timely and reasonable access to the Contractor’s personnel for the purpose of interview and discussion related to such documents. Reference: (2 CFR 200.336)

### **Record Retention Requirements**

The Contractor agrees financial records, supporting documents, statistical records, and all other Contractor records pertinent to the HUD CDBG-DR award shall be retained for a period of three years from the date of submission of the final expenditure report. HUD and the City may not impose any other record retention requirements upon the Contractor. The only exceptions are the following:

(a) If any litigation, claim, or audit is started before the expiration of the 3-year period, the records must be retained until all litigation, claims, or audit findings involving the records have been resolved and final action taken.

(b) When the Contractor is notified in writing by HUD, the cognizant agency for audit, oversight agency for audit, cognizant agency for indirect costs, or City of Moore to extend the retention period.

(c) Records for real property and equipment acquired with Federal funds must be retained for three years after final disposition.

(d) When records are transferred to or maintained by the HUD or the City of Moore, the 3-year retention requirement is not applicable to the Contractor. Reference: (2 CFR 200.333)

### **Remedies for Noncompliance**

If a Contractor fails to comply with Federal statutes, regulations or the terms and conditions of a Federal award, HUD or the City of Moore may impose additional conditions, as described in 2 CFR 200.207 Specific Conditions. If HUD or the City of Moore determines that noncompliance cannot be remedied by imposing additional conditions, HUD or the City of Moore may take one or more of the following actions, as appropriate in the circumstances:

(a) Temporarily withhold cash payments pending correction of the deficiency by the Contractor or more severe enforcement action by HUD or City of Moore.

(b) Disallow (that is, deny both use of funds and any applicable matching credit for) all or part of the cost of the activity or action not in compliance.

(c) Wholly or partly suspend or terminate the Federal award.

(d) Initiate suspension or debarment proceedings as authorized under 2 CFR part 180 and HUD regulations, or in the case of a City of Moore, recommend such a proceeding be initiated by HUD.

(e) Withhold further Federal awards for the project or program.

(f) Take other remedies that may be legally available.

Reference: (2 CFR 200.338)

## **Breaches and Dispute Resolution**

- (a) Disputes - Disputes arising in the performance of this Contract which are not resolved by agreement of the parties shall be decided in writing by the authorized representative of the City's Department of Capital Planning and Resiliency. This decision shall be final and conclusive unless within [ten (10)] calendar days from the date of receipt of its copy, the Contractor mails or otherwise furnishes a written appeal to authorized representative. In connection with any such appeal, the Contractor shall be afforded an opportunity to be heard and to offer evidence in support of its position. The decision of the authorized representative shall be binding upon the Contractor and the Contractor shall abide by the decision.
- (b) Performance During Dispute - Unless otherwise directed by to the City of Moore Department of Capital Planning and Resiliency, the Contractor shall continue performance under this Contract while matters in dispute are being resolved.
- (c) Claims for Damages - Should either party to the Contract suffer injury or damage to person or property because of any act or omission of the party or of any of his employees, agents or others for whose acts he is legally liable, a claim for damages therefor shall be made in writing to such other party within a reasonable time after the first observance of such injury of damage.
- (d) Remedies - Unless this contract provides otherwise, all claims, counterclaims, disputes and other matters in question between the City and the Contractor arising out of or relating to this Contract or its breach will be decided by arbitration in the City of Moore Department of Capital Planning and Resiliency if the parties mutually agree, or in a court of competent jurisdiction within the State of Oklahoma.
- (e) Rights and Remedies - The duties and obligations imposed by the Contract Documents and the rights and remedies available thereunder shall be in addition to and not a

limitation of any duties, obligations, rights and remedies otherwise imposed or available by law. No action or failure to act by the City of Moore or the Contractor shall constitute a waiver of any right or duty afforded any of them under the Contract, nor shall any such action or failure to act constitute an approval of or acquiescence in any breach thereunder, except as may be specifically agreed in writing. Reference: 49 CFR Part 18

## **Termination**

(a) The Contract may be terminated in whole or in part as follows:

(1) By the City of Moore, if a Contractor fails to comply with the terms and conditions of a Federal award;

(2) By the City of Moore for cause;

(3) By the City of Moore with the consent of the Contractor, in which case the two parties must agree upon the termination conditions, including the effective date and, in the case of partial termination, the portion to be terminated; or

(4) By the Contractor upon sending the City of Moore or HUD written notification setting forth the reasons for such termination, the effective date, and, in the case of partial termination, the portion to be terminated. However, if HUD or City of Moore determines in the case of partial termination that the reduced or modified portion of the Contract will not accomplish the purposes for which the Federal award was made, HUD or City of Moore may terminate the Contract in its entirety.

(b) When a Federal award is terminated or partially terminated, the City of Moore and the Contractor remain responsible for compliance with the requirements in 2 CFR 200.343 Closeout and 2 CFR 200.344 Post-closeout adjustments and continuing responsibilities. References: (2 CFR 200.339; 78 FR 78608, Dec. 26, 2013, as amended at 80 FR 43309, July 22, 2015)

## **Equal Opportunity**

The following equal employment opportunity requirements apply to the Contract:



- a) Race, Color, Creed, National Origin, Sex - In accordance with Title VII of the Civil Rights Act, as amended, 42 U.S.C. § 2000e, and Federal transit laws at 49 U.S.C. § 5332, the Contractor agrees to comply with all applicable equal employment opportunity requirements of U.S. Department of Labor (U.S. DOL) regulations, "Office of Federal Contract Compliance Programs, Equal Employment Opportunity, Department of Labor," 41 C.F.R. Parts 60 et seq ., (which implement Executive Order No. 11246, "Equal Employment Opportunity," as amended by Executive Order No. 11375, "Amending Executive Order 11246 Relating to Equal Employment Opportunity," 42 U.S.C. § 2000e note), and with any applicable Federal statutes, executive orders, regulations, and Federal policies that may in the future affect construction activities undertaken in the course of the Project. The Contractor agrees to take affirmative action to ensure that applicants are employed, and that employees are treated during employment, without regard to their race, color, creed, national origin, sex, or age. Such action shall include, but not be limited to, the following: employment, upgrading, demotion or transfer, recruitment or recruitment advertising, layoff or termination; rates of pay or other forms of compensation; and selection for training, including apprenticeship. In addition, the Contractor agrees to comply with any implementing requirements HUD may issue.
- b) Age - In accordance with section 4 of the Age Discrimination in Employment Act of 1967, as amended, 29 U.S.C. § § 623 and Federal transit law at 49 U.S.C. § 5332, the Contractor agrees to refrain from discrimination against present and prospective employees for reason of age. In addition, the Contractor agrees to comply with any implementing requirements HUD may issue.
- c) Disabilities - In accordance with section 102 of the Americans with Disabilities Act, as amended, 42 U.S.C. § 12112, the Contractor agrees that it will comply with the requirements of U.S. Equal Employment Opportunity Commission, "Regulations to Implement the Equal Employment Provisions of the Americans with Disabilities Act," 29 C.F.R. Part 1630, pertaining to employment of persons with disabilities. In addition, the Contractor agrees to comply with any implementing requirements HUD may issue.

References: Executive Order 11246 September 24, 1965 as amended by Executive Order 11375 of October 13, 1967, and as supplemented in Department of Labor regulations 41 CFR chapter 60

## Civil Rights

- 1) Nondiscrimination - In accordance with Title VI of the Civil Rights Act, as amended, 42 U.S.C. § 2000d, section 303 of the Age Discrimination Act of 1975, as amended, 42 U.S.C. § 6102, section 202 of the Americans with Disabilities Act of 1990, 42 U.S.C. § 12132, and Federal transit law at 49 U.S.C. § 5332, the Contractor agrees that it will not discriminate against any employee or applicant for employment because of race, color, creed, national origin, sex, age, or disability. In addition, the Contractor agrees to comply with applicable Federal implementing regulations and other implementing requirements HUD may issue.
- 2) The Contractor agrees to comply with the non-discrimination in employment and contracting opportunities laws, regulations, and executive orders referenced in 24 CFR 570.607, as revised by Executive Order 13279. The applicable non-discrimination provisions in Section 109 of the HCDA are still applicable.
- 3) The Contractor agrees to comply with Title VI of the Civil Rights Act of 1964 as amended, Title VIII of the Civil Rights Act of 1968 as amended, Section 104(b) and Section 109 of Title I of the Housing and Community Development Act of 1974 as amended, Section 504 of the Rehabilitation Act of 1973, the Americans with Disabilities Act of 1990, the Age Discrimination Act of 1975, Executive Order 11063, and Executive Order 11246 as amended by Executive Orders 11375, 11478, 12107 and 12086.
- 4) The Contractor agrees to meet the Section 3 requirements as provided for in the [City's Section 3 Plan](#)
- 5) The contractor must ensure that facilities provided for employees are provided in such a manner that segregation on the basis of race, color, religion, sex, sexual orientation, gender identity, or national origin cannot result. The contractor may neither require such segregated use by written or oral policies nor tolerate such use by employee custom. The contractor's obligation extends further to ensuring that its employees are

not assigned to perform their services at any location, under the contractor's control, where the facilities are segregated. This obligation extends to all contracts containing the equal opportunity clause regardless of the amount of the contract. The term "facilities," as used in this section, means waiting rooms, work areas, restaurants and other eating areas, time clocks, restrooms, wash rooms, locker rooms, and other storage or dressing areas, parking lots, drinking fountains, recreation or entertainment areas, transportation, and housing provided for employees; Provided, That separate or single-user restrooms and necessary dressing or sleeping areas shall be provided to assure privacy between the sexes.

References: 29 U.S.C. § 623, 42 U.S.C. § 2000, 42 U.S.C. § 6102, 42 U.S.C. § 12112, 42 U.S.C. § 12132, 49 U.S.C. § 5332, 29 CFR Part 1630, 41 CFR Parts 60 et seq.

### **Conflict of Interest**

Any person who is an employee, agent, consultant, officer, or elected official or appointed official of the City of Moore, or of any of the City's subsidiaries, who exercises or have exercised any functions or responsibilities with respect to CDBG activities assisted, or who are in a position to participate in a decision making process or gain inside information with regard to such activities, may obtain a financial interest or benefit from a CDBG-assisted activity, or have a financial interest in any contract, subcontract, or agreement with respect to a CDBG-assisted activity, or with respect to the proceeds of the CDBG-assisted activity, either for themselves or those with whom they have business or immediate family ties, during their tenure or for one year after such decision making responsibilities have ended. Reference: 2 CFR 200.112

### **Patent rights**

1.) The contractor agrees to execute or to have executed and promptly deliver to the City all instruments necessary to (i) establish or confirm the rights the Government has throughout the world in those subject inventions to which the contractor elects to retain title, and (ii) convey title to the City when requested under paragraph (d) above and to enable the government to obtain patent protection throughout the world in that subject invention.

2.) The contractor agrees to require, by written agreement, its employees, other than clerical and nontechnical employees, to disclose promptly in writing to personnel identified as responsible for the administration of patent matters and in a format suggested by the contractor each subject invention made under contract in order that the contractor can comply with the disclosure provisions of paragraph (c), above, and to execute all papers necessary to file patent applications on subject inventions and to establish the government's rights in the subject inventions. This disclosure format should require, as a minimum, the information required by (c)(1), above. The contractor shall instruct such employees through employee agreements or other suitable educational programs on the importance of reporting inventions in sufficient time to permit the filing of patent applications prior to U.S. or foreign statutory bars.

3.) The contractor will notify the City of any decisions not to continue the prosecution of a patent application, pay maintenance fees, or defend in a reexamination or opposition proceeding on a patent, in any country, not less than thirty days before the expiration of the response period required by the relevant patent office.

4.) The contractor agrees to include, within the specification of any United States patent applications and any patent issuing thereon covering a subject invention, the following statement, "This invention was made with government support under (identify the contract) awarded by (identify the agency). The government has certain rights in the invention."

**Subcontracts:**

5.) The contractor will include this clause, suitably modified to identify the parties, in all subcontracts, regardless of tier, for experimental, developmental or research work to be performed by a small business firm or domestic nonprofit organization. The subcontractor will retain all rights provided for the contractor in this clause, and the contractor will not, as part of the consideration for awarding the subcontract, obtain rights in the subcontractor's subject inventions.

6.) The contractor will include in all other subcontracts, regardless of tier, for experimental developmental or research work the patent rights clause required by (cite section of agency implementing regulations or FAR).

7.) In the case of subcontracts, at any tier, when the prime award with the City was a contract (but not a grant or cooperative agreement), the City, subcontractor, and the contractor agree that the mutual obligations of the parties created by this clause constitute a contract between the subcontractor and the City with respect to the matters covered by the clause; provided, however, that nothing in this paragraph is intended to confer any jurisdiction under the Contract Disputes Act in connection with proceedings under paragraph (j) of this clause.

## **Copyrights**

HUD and the City of Moore reserve a royalty-free, nonexclusive, and irrevocable license to reproduce, publish or otherwise use, and to authorize others to use, for Federal Government purposes: The copyright in any work developed under the Contract, and to any rights of copyright to which a Contractor or Sub-contractor purchases ownership with grant support. Reference: 24 CFR Subtitle A. 85.34 Copyrights

## **Lobbying**

Contractors who apply or bid for an award of \$100,000 or more shall file the certification required by 49 CFR Part 20, "New Restrictions on Lobbying." Each tier certifies to the tier above that it will not and has not used Federal appropriated funds to pay any person or organization for influencing or attempting to influence an officer or employee of any agency, a member of Congress, officer or employee of Congress, or an employee of member of Congress in connection with obtaining any Federal contract, grant or any other award covered by 31 U.S.C. 1352. Each tier shall also disclose the name of any registrant under the Lobbying Disclosure Act of 1995 who has made lobbying contacts on its behalf with non-Federal funds with respect to that Federal contract, grant or award covered by 31 U.S.C. 1352. Such disclosures are forwarded from tier to tier up to the City of Moore.

References: (31 U.S.C. 1352 as amended by the Lobbying Disclosure Act of 1995, P.L. 104-65; 49 CFR Part 19, 49 CFR Part 20)

## **Environmental Requirements**

### **Clean Air**

1) The Contractor agrees to comply with all applicable standards, orders or regulations issued pursuant to the Clean Air Act, as amended, 42 U.S.C. §§ 7401 et seq. The Contractor agrees to report each violation to the Purchaser and understands and agrees that the Purchaser will, in turn, report each violation as required to assure notification and the appropriate EPA Regional Office.

2) The Contractor also agrees to include these requirements in each subcontract exceeding \$100,000 financed in whole or in part with Federal Assurances provided by HUD.

References: 42 U.S.C. 7401 et seq., 40 CFR 15.61, 49 CFR Part 18 (over \$100,000)

### **Clean Water**

1) The Contractor agrees to comply with all applicable standards, orders or regulations issued pursuant to the Federal Water Pollution Control Act, as amended, 33 U.S.C. 1251 et seq. The Contractor agrees to report each violation to the City of Moore Department of Capital Planning and Resiliency and understands and agrees that the Purchaser will, in turn, report each violation as required to assure notifications the appropriate EPA Regional Office.

2) The Contractor also agrees to include these requirements in each subcontract exceeding \$100,000 financed in whole or in part with HUD.

References: 33 U.S.C. 1251 (over \$100,000)

### **Energy Conservation**

The Contractor agrees to comply with mandatory standards and policies relating to energy efficiency, which are contained in the state energy conservation plan issued in compliance with the Energy Policy and Conservation Act.

References: 42 U.S.C. 6321 et. Seq., 49 CFR Part 18

### **Recycled Products**

The Contractor agrees to comply with all the requirements of Section 6002 of the Resource Conservation and Recovery Act (RCRA), as amended (42 U.S.C. 6962), including but not limited to

the regulatory provisions of 40 CFR Part 247, and Executive Order 12873, as they apply to the procurement of the items designated in Subpart B of 40 CFR Part 247.

References: 42 U.S.C. 6962, 40 CFR Part 247, Executive Order 12873 (More than \$10,000)

### **Environmental Conditions Discovered During Construction**

1) The Contractor agrees to cease work and immediately notify the Assistant City Manager and Compliance Specialist should a previously unknown environmental condition be discovered in the course of construction;

2) The Contractor understands that the discovery of an environmental condition requires the City to revise the Environmental Review Record (ERR) and that work on the portion of the project designated by the City must cease until the ERR is revised.

3) The Assistant City Manager will issue a new Notice to Proceed once the Environmental Review has been updated or the environmental condition has been cleared. References: 24 CFR Part 58.47

### **Section 504 and Americans with Disabilities Act**

The Contractor agrees and understands the requirements of the Americans with Disabilities Act (ADA) and Section 504 of the Rehabilitation Act of 1973 and requirement that: sidewalks, pedestrian overpasses, underpasses, and ramps constructed with Federal financial assistance must be accessible.

References: 36 CFR Part 1190 Minimum Guidelines and Requirements for Accessible Design

## **Section 4: Bonds, Insurance & Licenses**

### **Bond Requirements**

No surety will be accepted by the City from a Contractor that is now in default or delinquent on any bond or has an interest in any litigation against the City. All bonds shall be executed by surety

companies licensed to do business in the State of Oklahoma and acceptable to the Council. Each bond shall be executed by the Contractor and the Surety.

The City requires the following bonds:

**Maintenance Bond:**

A good and sufficient Maintenance Bond shall be required in an amount equal to one hundred (100) percent of the total amount of the contract Work Order, guaranteeing such improvements against defective workmanship and/or materials for a period of one (1) year from and after the time of completion and acceptance by the City of said improvements.

**Performance Bond:**

A good and sufficient Performance Bond shall be required in an amount equal to one hundred (100) percent of the total contract Work Order amount guaranteeing execution and completion of the work in accordance with the specifications

**Statutory Bond:**

A good and sufficient Statutory Bond shall be required in an amount equal to one hundred (100) percent of the total contact Work Order amount guaranteeing payment in full for all materials and labor used in the construction of the work.

**Insurance Requirements**

The Contractor assumes all risks incident to or in connection with its purpose to be conducted herein under and shall indemnify, defend and save the City of Moore harmless from damage or injuries of whatever nature or kind to persons or property arising directly or indirectly out of the Contractor's operations and arising from acts or omissions of its employees and shall indemnify, defend, save harmless the City of Moore from any penalties for violation of any law, ordinance or regulation affecting or having application to said operation or resulting from the carelessness, negligence or improper conduct of Contractor or any of its agents or employees. In this connection, the Contractor shall carry Insurances in the following amounts:



<b>Commercial Liability</b>	\$1,000,000 Each Occurrence
	\$1,000,000 General Aggregate
Must include coverage for blanket contractual liability for the obligations assumed under contract	
<b>Comprehensive Automobile Liability</b>	\$1,000,000 Combined Single Limit Each Occurrence
Coverage must extend to all owned, non-owned, leased, hired or borrowed vehicles and must include coverage for blanket contractual liability for the obligations assumed under contract	
<b>Workers' Compensation</b>	Statutory Limits where Services are to be performed
Must include coverage for Longshoremen's and Harbor Workers' Compensation, if applicable, and coverage for Federal Employers' Liability Act, if applicable	
<b>Employer's Liability</b>	\$1,000,000 Each Occurrence
	\$1,000,000 Disease per Employee
An Umbrella liability policy, which follows form, may be used to obtain the aforementioned limits	
<b>Professional Liability (if applicable)</b>	\$1,000,000 Each Claim
	\$2,000,000 General Aggregate

The City of Moore shall be furnished with a certificate of insurance, which shall provide that such insurance shall not be changed or canceled, without ten days prior written notice to the City of Moore. THE POLICY SHALL LIST THE CITY OF MOORE AS CO-INSURED OR ADDITIONAL INSURED.

Certificates of Insurance shall be delivered to the City of Moore prior to the issuance of any Work Order

### License Requirements

The Contractor assumes all responsibility for insuring the Contractor and all sub-contractors maintain all applicable federal, state or local Licenses necessary to perform the work required.

## Section 5: Notice to Proceed, Invoices, and Payment

### Notice to Proceed

- 1) The Contractor will receive a Notice to Proceed from the City which will describe the scope of services specific to the construction project or task;
- 2) The Notice To Proceed will establish the start date for the project.
  - a. Any work undertaken prior to receiving a signed and dated Notice to Proceed from the City shall be at the Contractor's complete expense and risk.
- 3) The Project number, I-03-W-LMA, shall be identified and included in all Invoices.
- 4) A Notice to Proceed will not be issued until the Department of Capital Planning and Resiliency has received insurance and bonds.

### Invoices

The City agrees to pay the Contractor for services rendered on the following schedule, terms and conditions:

- 1) The Contractor's sub-contractors are contained in [Appendix B](#)
  - a) The Contractor may amend the sub-contractor list in accordance with [Section 8: Modification or Amendment](#)
- 2) The Contractor agrees to meet all of the Federal Labor Standard Provisions contained in [Appendix C](#); and
  - a) To submit Davis Bacon Payrolls weekly to the Compliance Specialist
- 3) The Contractor agrees to meet the Section 3 requirements as provided for in the [City's Section 3 Plan](#); and
  - a) To submit Section 3 reports weekly to the Compliance Specialist
- 4) The Contractor agrees to meet the Minority Owned, Women Owned or Section 3 business reporting requirements contained in [Appendix D](#) at the time of the Invoice;

- 5) The Contractor shall be permitted to invoice the City once each month during the contract period for reimbursement of Unit Costs.
- 6) For an Invoice to be considered “properly submitted”:
  - a) The Invoice must be identified by Work Order Number, I-03-W-LMA, be complete, accurate, have all required documentation; be signed and dated; and
  - b) All Davis-Bacon; Section 3 and Minority Owned, Women Owned or Section 3 business reporting requirements must be current, complete, compliant and signed and dated.

## **Payments**

- 1) The City agrees to make full payment of any “properly submitted” invoice within thirty days of the invoice date.
- 2) Unless otherwise stipulated all payments will be made by electronic funds transfer from the City to the Contractor

## **Adjustments to Rate Schedule**

- 1) The Unit Prices defined in Appendix A may be adjusted once per year on the contract anniversary date.
- 2) The Contractor will propose rate adjustments to compensate for cost increases in materials, fuel, insurance etc.
  - a. These material adjustments must be documented to the full satisfaction of the City of Moore.
- 3) Labor rate adjustments or cost of living increases for labor may not exceed the U.S. Labor Department's U.S. City Average South West Region C.P.I. for the immediately preceding calendar year;
- 4) If the Contractor and the City of Moore cannot agree on the amount of rate adjustments, the Contractor or the City of Moore may elect to terminate the contract as provided for in [Section 3: Termination](#)

- 5) If the parties elect to terminate the Contract, the Contractor shall be bound to complete any projects currently under construction at the current contract rates or for a term of no longer than 90 days at the discretion of the City of Moore.

## **Section 6: Proprietary Information**

The parties agree that each will hold any proprietary information learned as a result of this Contract in confidence. The parties will not, during or after the term of this Contract, disclose such proprietary information to any other person or entity for any reason whatsoever, unless required by Title 51 O.S. Section 24A.1 et. seq.; also known as the State of Oklahoma Open Records Act.

## **Section 7: Understanding and Authorization**

This Contract shall constitute the entire understanding of the parties and any other understanding or representation of any kind shall not be binding upon either party. Each party represents that they are authorized by their organization to enter into this Contract and to bind their organization to its terms.

## **Section 8: Modification or Amendment**

Any modification of this Contract or additional obligations assumed by either party in connection with this Contract shall be binding only if placed in writing and signed by each party or an authorized representative thereof. Should any portion of this Contract be found to be invalid it shall not be deemed to invalidate the entire Contract.

## **Section 9: Execution**

This Contract may be executed in any number of counterparts, each of which shall be deemed an original, however all of which together shall constitute one and the same instrument.

## Section 10: Notifications

All notifications concerning this Contract shall be sent to the following addresses:

To: The City of Moore at:

Jared Jakubowski

Capital Planning and Resiliency

City of Moore

301 N. Broadway

Moore, Oklahoma 73160

To: David Parker at:

Matthews Trenching Company, Inc.

PO Box 15479

Oklahoma City, OK 73135

IN WITNESS WHEREOF, each party has caused this Contract to be executed on the date indicated below,

**The City of Moore:**

  
\_\_\_\_\_  
Glenn Lewis, Mayor

Date: 4-3-17

  
\_\_\_\_\_  
Linda Stewart, City Clerk

  
\_\_\_\_\_  
Randy Brink, City Attorney

**Matthews Trenching Company, Inc.**

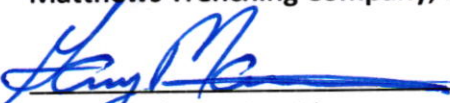
  
\_\_\_\_\_  
Gary Matthews, President

Date: 4-3-17

## EXHIBIT G

### Form 4400-A: Uniform Cost/Price Analysis

Complete Form 4400 for the RFP by defining each Benchmark or Deliverable where a payment is expected, the Target Date for Delivery, the amount of Payment, and the Percent of the Total Bid

THE UNDERSIGNED BIDDER, having carefully examined the drawings, specifications, and other Contract Documents of the above project presently on file in the office of the City Clerk, City of Moore, Oklahoma:

CERTIFIES THAT he has inspected the site of the proposed work and has full knowledge of the extent and character of the work involved, construction difficulties that may be encountered, and materials necessary for construction, class and type of excavation, and all other factors affecting or which may be affected by the specified work; and

CERTIFIES THAT he has not entered into collusion with any other bidder or prospective bidder relative to the project and/or bid; and

HEREBY PROPOSES: to enter into a contract to provide all necessary, labor, materials, equipment and tools to completely construct and finish all the work required by the Contract Documents hereto attached and other documents referred to therein; to complete said work with in one year (1) year after the work order is issued and to accept in full payment therefore the amounts set forth below for all work actually performed as computed by the Engineer as set forth in the Contract.

Benchmark or Deliverable	Quantity	Target Date	Amount	Percent of Total Bid
Pipe Bursting 20" (HDPE) (SDR19)	148 LF	TBD	14,800.00	3%
8" PVC Pipe	516 LF		18,060.00	4%
24" PVC Pipe	2,018 LF		90,810.00	13%
Steel Encasement Pipe	70 LF		8,750.00	2%
Trench Excavation	2,534 LF		25,340.00	13.21%
Standard Bedding Material	1,460 CY		43,800.00	9%
Construct 5' Diameter Manhole	7 Each		17,500.00	12%
Extra Depth 5' Diameter Manhole	67 VF		23,450.00	6%
Manhole Frame and Lid	9 Each		2,925.00	.75%
Sanitary Sewer Manhole Rehabilitation (5' Diameter)	28 VF		4,480.00	1%
Remove and Replace Sidewalk/Trail	197 SY		11,820.00	3%
Sawing Pavement	92 LF		368.00	.09%
Construction Signing and Traffic Control	1 LS		1,500.00	.38%
Mobilization/Demobilization	1 LS		1,200.00	.31%
Solid Slab Sodding	4,367 SY		17,468.00	4.5%
Rip Rap	158 SY		11,850.00	3%
Class A Concrete	98 CY		54,880.00	14%
Reinforcing Steel	853 LB		1,492.75	.38%
Sewer Service Connections	3 Each		1,500.00	.38%
Sewer Service Line	100 LF		2,000.00	.51%
Silt Fence	2,375 LF		9,500.00	2.5%
Abandon Sewer	20 CY		2,500.00	.64%
Abandon Manhole	5 Each		1,250.00	.32%
Deflection Test	1 LS		1,500.00	.38%
Sewer Flow Control	1 LS		8,500.00	2%
Leakage Test	1 LS		1,500.00	.38%
Pre-Construction Television Inspection (CCTV) & Cleaning	148 LF		592.00	.15%

Post-Construction Television Inspection	148 LF	TBD	296.00	.08%
---	--------	-----	--------	------



Construction 4' Diameter Manhole	2 Each	TBD	3,000.00	.77%
Extra Depth 4' Diameter Manhole	6 VF	TBD	1,050.00	.27%
Dewatering	1 LS	TBD	3,000.00	1%
GPS As-Built Survey	1 LS	TBD	3,000.00	1%
<b>TOTAL BID</b>			<b>389,681.75--</b>	

**Add Alternate #1**

<b>Benchmark or Deliverable</b>	<b>Quantity</b>	<b>Target Date</b>	<b>Amount</b>	<b>Percent of Total Bid</b>
Pipe Bursting 26" Pipe (HDPE) (SDR 19)	1,789 LF	TBD	241,515.00	74.45%
Construct 5' Diameter Manhole	5 Each		12,500.00	3.85%
Extra Depth 5' Diameter Manhole	33 VF		11,550.00	3.56%
Manhole Frame and Lid	5 Each		1,625.00	.5%
Sanitary Sewer Manhole Rehabilitation (5' Diameter)	55 VF		8,800.00	2.71%
Point Repair	100 LF		15,000.00	4.62%
Remove and Replace Sidewalk/Trail	83 SY		4,980.00	1.54%
Sawing Pavement	16 LF		64.00	.02%
Construction Signing and Traffic Control	1 LS		2,000.00	.62%
Mobilization/Demobilization	1 LS		1,500.00	.46%
Solid Slab Sodding	1 LS		1,500.00	.46%
Silt Fence	70 LF		280.00	.09%
Sewer Flow Control	1 LS		12,350.00	3.81%
Leakage Test	1 LS		1,500.00	.31%
Pre-construction Television Inspection (CCTV) & Cleaning	1,789 LF		7,156.00	2%
Post Construction Television Inspection	1,789 LF		3,578.00	1%
<b>Total Bid for Add Alternate #1</b>			<b>328,898.00---</b>	

**Add Alternate #2**

<b>Benchmark or Deliverable</b>	<b>Quantity</b>	<b>Target Date</b>	<b>Amount</b>	<b>Percent of Total Bid</b>
Pipe Bursting 26" Pipe (HDPE) (SDR 19)	2,374 LF	TBD	427,320.00	72.57%
Construct 5' Diameter Manhole	7 Each		17,500.00	3.82%
Extra Depth 5' Diameter Manhole	40 VF		14,000.00	3.06%
Manhole Frame and Lid	7 Each		2,275.00	.50%
Sanitary Sewer Manhole Rehabilitation (5' Diameter)	71 VF		11,360.00	2.48%
Point Repair	100 LF		13,000.00	2.84%
8" Concrete Driveway (H.E.S.)	80 SY		7,600.00	1.66%
Remove and Replace Sidewalk/Trail	239 SY		14,340.00	3.13%
Sawing Pavement	200 LF		800.00	.17%
Construction Signing and Traffic Control	1 LS		10,000.00	2.18%
Mobilization/Demobilization	1 LS		1,500.00	.33%
Sewer Flow Control	1 LS		20,000.00	3.82%
Leakage Test	1 LS		1,500.00	.33%
Pre-Construction Television Inspection (CCTV) & Cleaning	2,374 LF		9,496.00	2.07%
Post-Construction Television Inspection	2,374 LF		4,748.00	1.04%
<b>Total For Add Alternate #2</b>			<b>555,439.00---</b>	

**APPENDIX B: SUB-CONTRACTORS**

Ex	Concrete Curb and Gutter - Joe's Construction Company, 301 North Broadway, Moore, Oklahoma 73160 Joe Jones, President (405) 555-1212 office (405) 555-2121 cell <a href="mailto:joe.jones@JCC.com">joe.jones@JCC.com</a>
1	
2	
3	
4	
5	
6	
7	
8	
9	
10	

## Applicability

The Project or Program to which the construction work covered by this contract pertains is being assisted by the United States of America and the following Federal Labor Standards Provisions are included in this Contract pursuant to the provisions applicable to such Federal assistance.

**A. 1. (i) Minimum Wages.** All laborers and mechanics employed or working upon the site of the work, will be paid unconditionally and not less often than once a week, and without subsequent deduction or rebate on any account (except such payroll deductions as are permitted by regulations issued by the Secretary of Labor under the Copeland Act (29 CFR Part 3), the full amount of wages and bona fide fringe benefits (or cash equivalents thereof) due at time of payment computed at rates not less than those contained in the wage determination of the Secretary of Labor which is attached hereto and made a part hereof, regardless of any contractual relationship which may be alleged to exist between the contractor and such laborers and mechanics. Contributions made or costs reasonably anticipated for bona fide fringe benefits under Section I(b)(2) of the Davis-Bacon Act on behalf of laborers or mechanics are considered wages paid to such laborers or mechanics, subject to the provisions of 29 CFR 5.5(a)(1)(iv); also, regular contributions made or costs incurred for more than a weekly period (but not less often than quarterly) under plans, funds, or programs, which cover the particular weekly period, are deemed to be constructively made or incurred during such weekly period. Such laborers and mechanics shall be paid the appropriate wage rate and fringe benefits on the wage determination for the classification of work actually performed, without regard to skill, except as provided in 29 CFR 5.5(a)(4). Laborers or mechanics performing work in more than one classification may be compensated at the rate specified for each classification for the time actually worked therein: Provided, That the employer's payroll records accurately set forth the time spent in each classification in which work is performed. The wage determination (including any additional classification and wage rates conformed under 29 CFR 5.5(a)(1)(ii) and the Davis-Bacon poster (WH-1321) shall be posted at all times by the contractor and its subcontractors at the site of the work in a prominent and accessible, place where it can be easily seen by the workers.

**(ii) (a)** Any class of laborers or mechanics which is not listed in the wage determination and which is to be employed under the contract shall be classified in conformance with the wage determination. HUD shall approve an additional classification and wage rate and fringe benefits therefor only when the following criteria have been met:

**(1)** The work to be performed by the classification requested is not performed by a classification in the wage determination; and

**(2)** The classification is utilized in the area by the construction industry; and

**(3)** The proposed wage rate, including any bona fide fringe benefits, bears a reasonable relationship to the wage rates contained in the wage determination.

**(b)** If the contractor and the laborers and mechanics to be employed in the classification (if known), or their representatives, and HUD or its designee agree on the classification and wage rate (including the amount designated for fringe benefits where appropriate), a report of the action taken shall be sent by HUD or its designee to the Administrator of the Wage and Hour Division, Employment Standards Administration, U.S. Department of Labor, Washington, D.C. 20210. The Administrator, or an authorized representative, will approve, modify, or disapprove every additional classification action within 30 days of receipt and so advise HUD or its designee or will notify HUD or its designee within the 30-day period that additional time is necessary. (Approved by the Office of Management and Budget under OMB control number 1215-0140.)

**(c)** In the event the contractor, the laborers or mechanics to be employed in the classification or their representatives, and HUD or its designee do not agree on the proposed classification and wage rate (including the amount designated for fringe benefits, where appropriate), HUD or its designee shall refer the questions, including the views of all interested parties and the recommendation of HUD or its designee, to the Administrator for determination. The Administrator, or an authorized representative, will issue a determination within 30 days of receipt and so advise HUD or its designee or will notify HUD or its designee within the 30-day period that additional time is necessary. (Approved by the Office of Management and Budget under OMB Control Number 1215-0140.)

**(d)** The wage rate (including fringe benefits where appropriate) determined pursuant to subparagraphs (1)(ii)(b) or (c) of this paragraph, shall be paid to all workers performing work in the classification under this contract from the first day on which work is performed in the classification.

**(iii)** Whenever the minimum wage rate prescribed in the contract for a class of laborers or mechanics includes a fringe benefit which is not expressed as an hourly rate, the contractor shall either pay the benefit as stated in the wage determination or shall pay another bona fide fringe benefit or an hourly cash equivalent thereof.

**(iv)** If the contractor does not make payments to a trustee or other third person, the contractor may consider as part

of the wages of any laborer or mechanic the amount of any costs reasonably anticipated in providing bona fide fringe benefits under a plan or program, Provided, That the Secretary of Labor has found, upon the written request of the contractor, that the applicable standards of the Davis-Bacon Act have been met. The Secretary of Labor may require the contractor to set aside in a separate account assets for the meeting of obligations under the plan or program. (Approved by the Office of Management and Budget under OMB Control Number 1215-0140.)

**2. Withholding.** HUD or its designee shall upon its own action or upon written request of an authorized representative of the Department of Labor withhold or cause to be withheld from the contractor under this contract or any other Federal contract with the same prime contractor, or any other Federally-assisted contract subject to Davis-Bacon prevailing wage requirements, which is held by the same prime contractor so much of the accrued payments or advances as may be considered necessary to pay laborers and mechanics, including apprentices, trainees and helpers, employed by the contractor or any subcontractor the full amount of wages required by the contract. In the event of failure to pay any laborer or mechanic, including any apprentice, trainee or helper, employed or working on the site of the work, all or part of the wages required by the contract, HUD or its designee may, after written notice to the contractor, sponsor, applicant, or owner, take such action as may be necessary to cause the suspension of any further payment, advance, or guarantee of funds until such violations have ceased. HUD or its designee may, after written notice to the contractor, disburse such amounts withheld for and on account of the contractor or subcontractor to the respective employees to whom they are due. The Comptroller General shall make such disbursements in the case of direct Davis-Bacon Act contracts.

**3. (i) Payrolls and basic records.** Payrolls and basic records relating thereto shall be maintained by the contractor during the course of the work preserved for a period of three years thereafter for all laborers and mechanics working at the site of the work. Such records shall contain the name, address, and social security number of each such worker, his or her correct classification, hourly rates of wages paid (including rates of contributions or costs anticipated for bona fide fringe benefits or cash equivalents thereof of the types described in Section 1(b)(2)(B) of the Davis-bacon Act), daily and weekly number of hours worked, deductions made and actual wages paid. Whenever the Secretary of Labor has found under 29 CFR 5.5 (a)(1)(iv) that the wages of any laborer or mechanic include the amount of any costs reasonably anticipated in providing benefits under a plan or program described in Section 1(b)(2)(B) of the Davis-Bacon Act, the contractor shall maintain records which show that the commitment to provide such benefits is enforceable, that the plan or program is financially responsible, and that the plan or program has been

communicated in writing to the laborers or mechanics affected, and records which show the costs anticipated or the actual cost incurred in providing such benefits. Contractors employing apprentices or trainees under approved programs shall maintain written evidence of the registration of apprenticeship programs and certification of trainee programs, the registration of the apprentices and trainees, and the ratios and wage rates prescribed in the applicable programs. (Approved by the Office of Management and Budget under OMB Control Numbers 1215-0140 and 1215-0017.)

**(ii) (a)** The contractor shall submit weekly for each week in which any contract work is performed a copy of all payrolls to HUD or its designee if the agency is a party to the contract, but if the agency is not such a party, the contractor will submit the payrolls to the applicant sponsor, or owner, as the case may be, for transmission to HUD or its designee. The payrolls submitted shall set out accurately and completely all of the information required to be maintained under 29 CFR 5.5(a)(3)(i) except that full social security numbers and home addresses shall not be included on weekly transmittals. Instead the payrolls shall only need to include an individually identifying number for each employee (e.g., the last four digits of the employee's social security number). The required weekly payroll information may be submitted in any form desired. Optional Form WH-347 is available for this purpose from the Wage and Hour Division Web site at <http://www.dol.gov/esa/whd/forms/wh347instr.htm> or its successor site. The prime contractor is responsible for the submission of copies of payrolls by all subcontractors. Contractors and subcontractors shall maintain the full social security number and current address of each covered worker, and shall provide them upon request to HUD or its designee if the agency is a party to the contract, but if the agency is not such a party, the contractor will submit the payrolls to the applicant sponsor, or owner, as the case may be, for transmission to HUD or its designee, the contractor, or the Wage and Hour Division of the Department of Labor for purposes of an investigation or audit of compliance with prevailing wage requirements. It is not a violation of this subparagraph for a prime contractor to require a subcontractor to provide addresses and social security numbers to the prime contractor for its own records, without weekly submission to HUD or its designee. (Approved by the Office of Management and Budget under OMB Control Number 1215-0149.)

**(b)** Each payroll submitted shall be accompanied by a "Statement of Compliance," signed by the contractor or subcontractor or his or her agent who pays or supervises the payment of the persons employed under the contract and shall certify the following:

**(1)** That the payroll for the payroll period contains the information required to be provided under 29 CFR 5.5 (a)(3)(ii), the appropriate information is being maintained under 29 CFR 5.5(a)(3)(i), and that such information is correct and complete;

(2) That each laborer or mechanic (including each helper, apprentice, and trainee) employed on the contract during the payroll period has been paid the full weekly wages earned, without rebate, either directly or indirectly, and that no deductions have been made either directly or indirectly from the full wages earned, other than permissible deductions as set forth in 29 CFR Part 3;

(3) That each laborer or mechanic has been paid not less than the applicable wage rates and fringe benefits or cash equivalents for the classification of work performed, as specified in the applicable wage determination incorporated into the contract.

(c) The weekly submission of a properly executed certification set forth on the reverse side of Optional Form WH-347 shall satisfy the requirement for submission of the "Statement of Compliance" required by subparagraph A.3.(ii)(b).

(d) The falsification of any of the above certifications may subject the contractor or subcontractor to civil or criminal prosecution under Section 1001 of Title 18 and Section 231 of Title 31 of the United States Code.

(iii) The contractor or subcontractor shall make the records required under subparagraph A.3.(i) available for inspection, copying, or transcription by authorized representatives of HUD or its designee or the Department of Labor, and shall permit such representatives to interview employees during working hours on the job. If the contractor or subcontractor fails to submit the required records or to make them available, HUD or its designee may, after written notice to the contractor, sponsor, applicant or owner, take such action as may be necessary to cause the suspension of any further payment, advance, or guarantee of funds. Furthermore, failure to submit the required records upon request or to make such records available may be grounds for debarment action pursuant to 29 CFR 5.12.

#### 4. Apprentices and Trainees.

(i) **Apprentices.** Apprentices will be permitted to work at less than the predetermined rate for the work they performed when they are employed pursuant to and individually registered in a bona fide apprenticeship program registered with the U.S. Department of Labor, Employment and Training Administration, Office of Apprenticeship Training, Employer and Labor Services, or with a State Apprenticeship Agency recognized by the Office, or if a person is employed in his or her first 90 days of probationary employment as an apprentice in such an apprenticeship program, who is not individually registered in the program, but who has been certified by the Office of Apprenticeship Training, Employer and Labor Services or a State Apprenticeship Agency (where appropriate) to be eligible for probationary employment as an apprentice. The allowable ratio of apprentices to journeymen on the job site in any craft classification shall not be greater than the ratio permitted to the contractor as to the entire work force under the registered program. Any worker listed on a payroll at an apprentice wage rate, who

is not registered or otherwise employed as stated above, shall be paid not less than the applicable wage rate on the wage determination for the classification of work actually performed. In addition, any apprentice performing work on the job site in excess of the ratio permitted under the registered program shall be paid not less than the applicable wage rate on the wage determination for the work actually performed. Where a contractor is performing construction on a project in a locality other than that in which its program is registered, the ratios and wage rates (expressed in percentages of the journeyman's hourly rate) specified in the contractor's or subcontractor's registered program shall be observed. Every apprentice must be paid at not less than the rate specified in the registered program for the apprentice's level of progress, expressed as a percentage of the journeymen hourly rate specified in the applicable wage determination. Apprentices shall be paid fringe benefits in accordance with the provisions of the apprenticeship program. If the apprenticeship program does not specify fringe benefits, apprentices must be paid the full amount of fringe benefits listed on the wage determination for the applicable classification. If the Administrator determines that a different practice prevails for the applicable apprentice classification, fringes shall be paid in accordance with that determination. In the event the Office of Apprenticeship Training, Employer and Labor Services, or a State Apprenticeship Agency recognized by the Office, withdraws approval of an apprenticeship program, the contractor will no longer be permitted to utilize apprentices at less than the applicable predetermined rate for the work performed until an acceptable program is approved.

(ii) **Trainees.** Except as provided in 29 CFR 5.16, trainees will not be permitted to work at less than the predetermined rate for the work performed unless they are employed pursuant to and individually registered in a program which has received prior approval, evidenced by formal certification by the U.S. Department of Labor, Employment and Training Administration. The ratio of trainees to journeymen on the job site shall not be greater than permitted under the plan approved by the Employment and Training Administration. Every trainee must be paid at not less than the rate specified in the approved program for the trainee's level of progress, expressed as a percentage of the journeyman hourly rate specified in the applicable wage determination. Trainees shall be paid fringe benefits in accordance with the provisions of the trainee program. If the trainee program does not mention fringe benefits, trainees shall be paid the full amount of fringe benefits listed on the wage determination unless the Administrator of the Wage and Hour Division determines that there is an apprenticeship program associated with the corresponding journeyman wage rate on the wage determination which provides for less than full fringe benefits for apprentices. Any employee listed on the payroll at a trainee rate who is not registered and participating in a training plan approved by

the Employment and Training Administration shall be paid not less than the applicable wage rate on the wage determination for the work actually performed. In addition, any trainee performing work on the job site in excess of the ratio permitted under the registered program shall be paid not less than the applicable wage rate on the wage determination for the work actually performed. In the event the Employment and Training Administration withdraws approval of a training program, the contractor will no longer be permitted to utilize trainees at less than the applicable predetermined rate for the work performed until an acceptable program is approved.

**(iii) Equal employment opportunity.** The utilization of apprentices, trainees and journeymen under 29 CFR Part 5 shall be in conformity with the equal employment opportunity requirements of Executive Order 11246, as amended, and 29 CFR Part 30.

**5. Compliance with Copeland Act requirements.** The contractor shall comply with the requirements of 29 CFR Part 3 which are incorporated by reference in this contract

**6. Subcontracts.** The contractor or subcontractor will insert in any subcontracts the clauses contained in subparagraphs 1 through 11 in this paragraph A and such other clauses as HUD or its designee may by appropriate instructions require, and a copy of the applicable prevailing wage decision, and also a clause requiring the subcontractors to include these clauses in any lower tier subcontracts. The prime contractor shall be responsible for the compliance by any subcontractor or lower tier subcontractor with all the contract clauses in this paragraph.

**7. Contract termination; debarment.** A breach of the contract clauses in 29 CFR 5.5 may be grounds for termination of the contract and for debarment as a contractor and a subcontractor as provided in 29 CFR 5.12.

**8. Compliance with Davis-Bacon and Related Act Requirements.** All rulings and interpretations of the Davis-Bacon and Related Acts contained in 29 CFR Parts 1, 3, and 5 are herein incorporated by reference in this contract

**9. Disputes concerning labor standards.** Disputes arising out of the labor standards provisions of this contract shall not be subject to the general disputes clause of this contract. Such disputes shall be resolved in accordance with the procedures of the Department of Labor set forth in 29 CFR Parts 5, 6, and 7. Disputes within the meaning of this clause include disputes between the contractor (or any of its subcontractors) and HUD or its designee, the U.S. Department of Labor, or the employees or their representatives.

**10. (i) Certification of Eligibility.** By entering into this contract the contractor certifies that neither it (nor he or she) nor any person or firm who has an interest in the contractor's firm is a person or firm ineligible to be awarded Government contracts by virtue of Section 3(a) of the Davis-Bacon Act or 29 CFR 5.12(a)(1) or to be

awarded HUD contracts or participate in HUD programs pursuant to 24 CFR Part 24.

**(ii)** No part of this contract shall be subcontracted to any person or firm ineligible for award of a Government contract by virtue of Section 3(a) of the Davis-Bacon Act or 29 CFR 5.12(a)(1) or to be awarded HUD contracts or participate in HUD programs pursuant to 24 CFR Part 24.

**(iii)** The penalty for making false statements is prescribed in the U.S. Criminal Code, 18 U.S.C. 1001. Additionally, U.S. Criminal Code, Section 1 01 0, Title 18, U.S.C., "Federal Housing Administration transactions", provides in part: "Whoever, for the purpose of . . . influencing in any way the action of such Administration..... makes, utters or publishes any statement knowing the same to be false..... shall be fined not more than \$5,000 or imprisoned not more than two years, or both."

**11. Complaints, Proceedings, or Testimony by Employees.** No laborer or mechanic to whom the wage, salary, or other labor standards provisions of this Contract are applicable shall be discharged or in any other manner discriminated against by the Contractor or any subcontractor because such employee has filed any complaint or instituted or caused to be instituted any proceeding or has testified or is about to testify in any proceeding under or relating to the labor standards applicable under this Contract to his employer.

**B. Contract Work Hours and Safety Standards Act.** The provisions of this paragraph B are applicable where the amount of the prime contract exceeds \$100,000. As used in this paragraph, the terms "laborers" and "mechanics" include watchmen and guards.

**(1) Overtime requirements.** No contractor or subcontractor contracting for any part of the contract work which may require or involve the employment of laborers or mechanics shall require or permit any such laborer or mechanic in any workweek in which the individual is employed on such work to work in excess of 40 hours in such workweek unless such laborer or mechanic receives compensation at a rate not less than one and one-half times the basic rate of pay for all hours worked in excess of 40 hours in such workweek.

**(2) Violation; liability for unpaid wages; liquidated damages.** In the event of any violation of the clause set forth in subparagraph (1) of this paragraph, the contractor and any subcontractor responsible therefor shall be liable for the unpaid wages. In addition, such contractor and subcontractor shall be liable to the United States (in the case of work done under contract for the District of Columbia or a territory, to such District or to such territory), for liquidated damages. Such liquidated damages shall be computed with respect to each individual laborer or mechanic, including watchmen and guards, employed in violation of the clause set forth in subparagraph (1) of this paragraph, in the sum of \$10 for each calendar day on which such individual was required or permitted to work in excess of the standard workweek of 40 hours without payment of the overtime wages required by the clause set forth in subparagraph (1) of this paragraph.

---

**(3) Withholding for unpaid wages and liquidated damages.** HUD or its designee shall upon its own action or upon written request of an authorized representative of the Department of Labor withhold or cause to be withheld, from any moneys payable on account of work performed by the contractor or subcontractor under any such contract or any other Federal contract with the same prime contract, or any other Federally-assisted contract subject to the Contract Work Hours and Safety Standards Act which is held by the same prime contractor such sums as may be determined to be necessary to satisfy any liabilities of such contractor or subcontractor for unpaid wages and liquidated damages as provided in the clause set forth in subparagraph (2) of this paragraph.

**(4) Subcontracts.** The contractor or subcontractor shall insert in any subcontracts the clauses set forth in subparagraph (1) through (4) of this paragraph and also a clause requiring the subcontractors to include these clauses in any lower tier subcontracts. The prime contractor shall be responsible for compliance by any subcontractor or lower tier subcontractor with the clauses set forth in subparagraphs (1) through (4) of this paragraph.

**C. Health and Safety.** The provisions of this paragraph C are applicable where the amount of the prime contract exceeds \$100,000.

**(1)** No laborer or mechanic shall be required to work in surroundings or under working conditions which are unsanitary, hazardous, or dangerous to his health and safety as determined under construction safety and health standards promulgated by the Secretary of Labor by regulation.

**(2)** The Contractor shall comply with all regulations issued by the Secretary of Labor pursuant to Title 29 Part 1926 and failure to comply may result in imposition of sanctions pursuant to the Contract Work Hours and Safety Standards Act, (Public Law 91-54, 83 Stat 96). 40 USC 3701 et seq.

**(3)** The contractor shall include the provisions of this paragraph in every subcontract so that such provisions will be binding on each subcontractor. The contractor shall take such action with respect to any subcontractor as the Secretary of Housing and Urban Development or the Secretary of Labor shall direct as a means of enforcing such provisions.



General Decision Number: OK170029 01/06/2017 OK29

Superseded General Decision Number: OK20160029

State: Oklahoma

Construction Type: Heavy

Counties: Canadian, Cleveland, Grady, Lincoln and McClain Counties in Oklahoma.

HEAVY CONSTRUCTION PROJECTS (including sewer/water line construction; heavy construction projects on treatment plants and industrial sites) (excludes heavy dredging and water well drilling)

Note: Under Executive Order (EO) 13658, an hourly minimum wage of \$10.20 for calendar year 2017 applies to all contracts subject to the Davis-Bacon Act for which the contract is awarded (and any solicitation was issued) on or after January 1, 2015. If this contract is covered by the EO, the contractor must pay all workers in any classification listed on this wage determination at least \$10.20 per hour (or the applicable wage rate listed on this wage determination, if it is higher) for all hours spent performing on the contract in calendar year 2017. The EO minimum wage rate will be adjusted annually. Additional information on contractor requirements and worker protections under the EO is available at [www.dol.gov/whd/govcontracts](http://www.dol.gov/whd/govcontracts).

Modification Number	Publication Date
0	01/06/2017

\* ENGI0627-015 06/01/2016

	Rates	Fringes
POWER EQUIPMENT OPERATOR:		
Group 1.....	\$ 28.05	12.58
Group 2.....	\$ 26.35	12.58
Group 3.....	\$ 25.80	12.58
Group 4.....	\$ 25.05	12.58
Group 5.....	\$ 24.55	12.58
Group 6.....	\$ 24.10	12.58
Group10.....	\$ 21.10	12.58

POWER EQUIPMENT OPERATOR

GROUP 1: All Crane Type Equipment 200 ton and larger and including 400 ton capacity cranes. All Tower Cranes.

GROUP 2: All Crane Type Equipment 100 ton capacity and larger cranes, and less than 200 ton capacity.

GROUP 3: All Crane Type Equipment 50 ton capacity and larger cranes, and less than 100 ton capacity. Crane Equipment (as rated by mfg.) 3 cu. yd. and over Guy derrick Whirley Power Driven Hole Digger (with 30' and longer mast).

GROUP 4: CRANES with Boom Incl. Jib less than 100 ft and less than 3 cu. Yd.; Overhead Monorail Crane

GROUP 5: BULLDOZER

GROUP 6: ROLLER (ASPHALT AND DIRT)

GROUP 10:OILER

-----  
 IRON0048-005 06/01/2013

	Rates	Fringes
IRONWORKER (Structural, Reinforcing, and Ornamental).....	\$ 23.10	12.88

-----  
 SUOK2012-007 05/18/2012

	Rates	Fringes
CEMENT MASON/CONCRETE FINISHER...	\$ 12.49	1.23
ELECTRICIAN.....	\$ 22.00	4.76
FORM WORKER.....	\$ 11.77	0.00
LABORER: Common or General.....	\$ 11.81	1.09
LABORER: Pipelayer.....	\$ 11.13	0.00
OPERATOR: Backhoe/Excavator.....	\$ 18.17	6.28
OPERATOR: Drill.....	\$ 17.15	0.78
OPERATOR: Grader/Blade.....	\$ 17.76	3.87
OPERATOR: Loader (Front End)....	\$ 13.51	0.00
OPERATOR: Mechanic.....	\$ 19.61	9.39
OPERATOR: Scraper.....	\$ 16.00	1.55
OPERATOR: Trackhoe.....	\$ 17.50	2.78
TRUCK DRIVER: Dump Truck.....	\$ 16.50	0.74

-----  
 WELDERS - Receive rate prescribed for craft performing operation to which welding is incidental.

=====

Note: Executive Order (EO) 13706, Establishing Paid Sick Leave for Federal Contractors applies to all contracts subject to the Davis-Bacon Act for which the contract is awarded (and any solicitation was issued) on or after January 1, 2017. If this contract is covered by the EO, the contractor must provide employees with 1 hour of paid sick leave for every 30 hours they work, up to 56 hours of paid sick leave each year. Employees must be permitted to use paid sick leave for their own illness, injury or other health-related needs, including preventive care; to assist a family member (or person who is like family to the employee) who is ill, injured, or has other health-related needs, including preventive care; or for reasons resulting from, or to assist a family member (or person who is like family to the employee) who is a victim of, domestic violence, sexual assault, or stalking. Additional information on contractor requirements and worker protections under the EO is available at [www.dol.gov/whd/govcontracts](http://www.dol.gov/whd/govcontracts).

Unlisted classifications needed for work not included within

the scope of the classifications listed may be added after award only as provided in the labor standards contract clauses (29CFR 5.5 (a) (1) (ii)).

-----

The body of each wage determination lists the classification and wage rates that have been found to be prevailing for the cited type(s) of construction in the area covered by the wage determination. The classifications are listed in alphabetical order of "identifiers" that indicate whether the particular rate is a union rate (current union negotiated rate for local), a survey rate (weighted average rate) or a union average rate (weighted union average rate).

#### Union Rate Identifiers

A four letter classification abbreviation identifier enclosed in dotted lines beginning with characters other than "SU" or "UAVG" denotes that the union classification and rate were prevailing for that classification in the survey. Example: PLUM0198-005 07/01/2014. PLUM is an abbreviation identifier of the union which prevailed in the survey for this classification, which in this example would be Plumbers. 0198 indicates the local union number or district council number where applicable, i.e., Plumbers Local 0198. The next number, 005 in the example, is an internal number used in processing the wage determination. 07/01/2014 is the effective date of the most current negotiated rate, which in this example is July 1, 2014.

Union prevailing wage rates are updated to reflect all rate changes in the collective bargaining agreement (CBA) governing this classification and rate.

#### Survey Rate Identifiers

Classifications listed under the "SU" identifier indicate that no one rate prevailed for this classification in the survey and the published rate is derived by computing a weighted average rate based on all the rates reported in the survey for that classification. As this weighted average rate includes all rates reported in the survey, it may include both union and non-union rates. Example: SULA2012-007 5/13/2014. SU indicates the rates are survey rates based on a weighted average calculation of rates and are not majority rates. LA indicates the State of Louisiana. 2012 is the year of survey on which these classifications and rates are based. The next number, 007 in the example, is an internal number used in producing the wage determination. 5/13/2014 indicates the survey completion date for the classifications and rates under that identifier.

Survey wage rates are not updated and remain in effect until a new survey is conducted.

#### Union Average Rate Identifiers

Classification(s) listed under the UAVG identifier indicate that no single majority rate prevailed for those classifications; however, 100% of the data reported for the classifications was union data. EXAMPLE: UAVG-OH-0010 08/29/2014. UAVG indicates that the rate is a weighted union average rate. OH indicates the state. The next number, 0010 in

the example, is an internal number used in producing the wage determination. 08/29/2014 indicates the survey completion date for the classifications and rates under that identifier.

A UAVG rate will be updated once a year, usually in January of each year, to reflect a weighted average of the current negotiated/CBA rate of the union locals from which the rate is based.

-----  
WAGE DETERMINATION APPEALS PROCESS

1.) Has there been an initial decision in the matter? This can be:

- \* an existing published wage determination
- \* a survey underlying a wage determination
- \* a Wage and Hour Division letter setting forth a position on a wage determination matter
- \* a conformance (additional classification and rate) ruling

On survey related matters, initial contact, including requests for summaries of surveys, should be with the Wage and Hour Regional Office for the area in which the survey was conducted because those Regional Offices have responsibility for the Davis-Bacon survey program. If the response from this initial contact is not satisfactory, then the process described in 2.) and 3.) should be followed.

With regard to any other matter not yet ripe for the formal process described here, initial contact should be with the Branch of Construction Wage Determinations. Write to:

Branch of Construction Wage Determinations  
Wage and Hour Division  
U.S. Department of Labor  
200 Constitution Avenue, N.W.  
Washington, DC 20210

2.) If the answer to the question in 1.) is yes, then an interested party (those affected by the action) can request review and reconsideration from the Wage and Hour Administrator (See 29 CFR Part 1.8 and 29 CFR Part 7). Write to:

Wage and Hour Administrator  
U.S. Department of Labor  
200 Constitution Avenue, N.W.  
Washington, DC 20210

The request should be accompanied by a full statement of the interested party's position and by any information (wage payment data, project description, area practice material, etc.) that the requestor considers relevant to the issue.

3.) If the decision of the Administrator is not favorable, an interested party may appeal directly to the Administrative Review Board (formerly the Wage Appeals Board). Write to:

Administrative Review Board  
U.S. Department of Labor  
200 Constitution Avenue, N.W.  
Washington, DC 20210

4.) All decisions by the Administrative Review Board are final.

=====

END OF GENERAL DECISION



## APPENDIX D: MINORITY, WOMEN OWNED OR SECTION 3 BUSINESS REPORTING

<b>MINORITY, WOMEN OWNED OR SECTION 3 BUSINESS REPORT</b>				
<b>CONTRACTOR</b>				
Invoice Date				
		<b>Total Amount of Invoice</b>		<b>\$1,322,956.21</b>
Name of MOB/WOB/Section 3 Business	MOB Amount	WOB Amount	Section 3 Amount	Percent of Invoice
<b>SIGNATURE</b>				
Printed Name and Position				
Date				

**FROM:** City of Moore  
301 N. Broadway  
Moore, OK 73160  
Tel.: 405/793-4571 Fax: 405/793-4573

**TO:** Prospective Bidders

**SUBJECT:** **Addendum No. 1** to the Bidding Documents  
City of Moore Bid #1617-03 – Little River Park Sanitary Sewer Interceptor  
Rehabilitation/Replacement

**DATE:** February 8, 2017

This Addendum modifies and takes precedence over the original plans and specifications and forms a part of the Contract Documents.

This Addendum consists of one (2) pages and (3) Attachments.

**Clarifications:**

1. The current wage rate General Wage Decision number OK20170029 is attached as shall be utilized as outlined in the Labor Requirements in the bid documents.
2. High Density Polyethelne (HDPE) Pipe shall utilize Iron Pipe Sizes (IPS).
3. Flow monitoring was conducted in December 2015 with an average flowrate of 1,200 GPM and peak flowrate of 4,600 gpm observed during that month.
4. Closed Profile Gravity Sewer Pipe is an engineer approved equivalent for Base Bid Pay Item 3, Sanitary Sewer Pipe. Pipe shall meet the requirements of ASTM F-1803, closed profile pipe. Pipe and fittings shall be made from polyvinyl chloride compounds which comply with the requirements for a minimum cell classification of 12364 as defined by ASTM D-1784. Pipe stiffness shall be a minimum of 46 PSI when tested in accordance with ASTM D-2412.
5. Exhibit G Form 4400 – Hourly Rates form must be completed and submitted with all bids. Specific employee names and compensation are not required, minimum wages per job classification may be listed and will be verified for selected contractor. Examples are as follows:

Laborer: Pipe layer	Employee	Min. \$##.## + fringe
Operator: Backhoe/Excavator	Sub-contractor	Min. \$##.## + fringe

**Plans:**

1. All work performed and materials supplied shall conform to the plans and/or project specifications. Any work not covered in the plans or specifications shall conform to the City of Oklahoma City "Standard specifications and construction Drawings" or the "Standard Specifications for Highway Construction, Oklahoma Department of Transportation, Edition of 2009" and supplementals.
2. Updated City of Oklahoma City Standards are attached and shall be utilized for construction.
3. Manholes #28 and #29 have been reduced to 4' diameter and bid items have been adjusted to reflect this change.

4. Dewatering has been added as a bid item.
5. GPS As-built Survey has been added as a bid item.



**FROM:** City of Moore  
301 N. Broadway  
Moore, OK 73160  
Tel.: 405/793-4571 Fax: 405/793-4573

**TO:** Prospective Bidders

**SUBJECT:** **Addendum No. 2** to the Bidding Documents  
City of Moore Bid #1617-03 – Little River Park Sanitary Sewer Interceptor  
Rehabilitation/Replacement

**DATE:** February 21, 2017

This Addendum modifies and takes precedence over the original plans and specifications and forms a part of the Contract Documents.

This Addendum consists of one (1) page and no Attachments.

**Clarifications:**

1. The opening of bids originally scheduled for February 21, 2017 has been postponed and rescheduled. Sealed bids will now be due by 9:45 on February 24, 2017 and opened at 10:00 a.m. on February 24, 2017. See proposal documents for additional information for proposal submittal.
2. 26-inch High Density Polyethelne (HDPE) Pipe may be black in color. Gray HDPE Pipe shall be utilized for the 20-inch pipe.
3. Closed Profile Gravity Sewer Pipe is no longer an engineer approved equivalent for Base Bid Pay Item 3, and shall not be utilized for bid proposal.
4. This project is tax exempt.

PLAN OF  
**LITTLE RIVER PARK SANITARY SEWER  
 INTERCEPTOR REHABILITATION/REPLACEMENT**

CITY OF MOORE PROJECT NO. I-03-W-LMA

R-3-W

Appendix F



The City of  
**MOORE**

ADAM WEBB  
 Council Member

MARK HAMM  
 Council Member

JASON BLAIR  
 Council Member

GLEN LEWIS  
 Mayor

BROOKS MITCHELL  
 City Manager

RANDY BRINK  
 City Attorney

DANIELLE MCKENZIE  
 Council Member

MELISSA HUNT  
 Council Member

TERRY CAVNAR  
 Council Member



PROJECT LOCATION

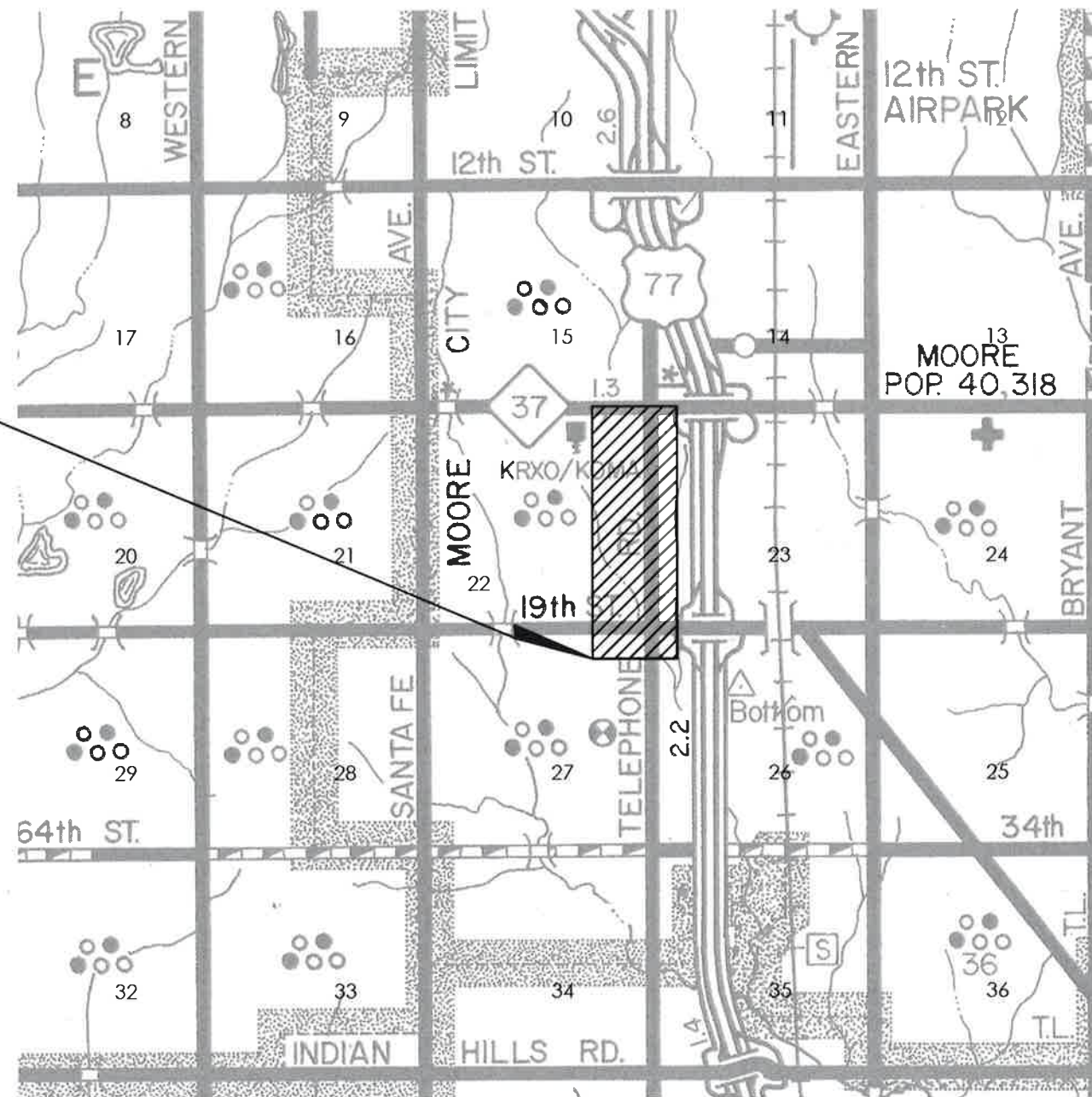

SHEET INDEX	
SHEET NO.	DESCRIPTION
1	TITLE SHEET
2	LOCATION MAP
3	SUMMARY SHEET
4-12	PLAN AND PROFILE SHEETS
13	CHANNEL LINER DETAILS
14-22	STANDARD DETAILS

ONE CALL UTILITY LOCATION NUMBER

(405) 840-5032  
 (800) 522-6543

THIS NUMBER IS TO BE USED FOR INFORMATION ON THE LOCATION OF ALL UNDERGROUND UTILITIES. CONTACT THIS NUMBER AND OTHER SPECIFIED NUMBERS IN THE PLANS PRIOR TO ANY EXCAVATION.

PREPARED BY:

*Michael A. Way*  
 MICHAEL A. WAY, PE  
 REGISTERED PROFESSIONAL ENGINEER NO. 27707



2/14/2017

LEGEND	
---	EXISTING CONTOUR
---	PROPOSED CONTOUR
X	FENCE
OHE	OVERHEAD ELECTRIC
○	POWER POLE
○	LIGHT POLE
W	WATER LINE
○	FIRE HYDRANT
○	GATE VALVE
○	WATER METER
FIB	FIBER OPTIC UNDERGROUND
TUG	TELEPHONE UNDERGROUND
UGF	POWER UNDERGROUND
CaTV	CABLE TV UNDERGROUND
---	GAS LINE
○	GAS METER
○	GAS VALVE
EXSS	SANITARY SEWER
---	STORM SEWER
---	GUARD POSTS
---	ROAD SIGNS
---	ROCK BAGS
XXXXXXX	SILTATION FENCE
---	EXISTING BUILDING
---	PROPOSED ASPHALT PAVING
---	PROPOSED P.C. CONCRETE
---	REMOVALS

**Cabbiness  
 Engineering, llc**  
 333 12th Avenue SE, Suite 200  
 Norman, Oklahoma 73071  
 405.310.6435 Office, 405.310.6495 Fax  
 www.CabbinessEngineering.com  
 Certificate of Authorization No. CA#5714 Expires June 30, 2018.

U:\Projects\251 - Moore CDBG Sewer Interceptor I-03-W-LMA\DWG\Moore City Title Sheet.dwg  
 1/20/2017 9:22 AM  
 Helen





U:\Projects\251 - Moore CDBG Sewer Interceptor\I-03-W-LMA\DWG\LOCATION MAP.dwg  
 Helen/2/13/2017 4:08 PM

SUMMARY OF PAY QUANTITIES - SANITARY SEWER				
NO.	DESCRIPTION	UNIT	QUANTITY	AS-BUILT
<b>BASE BID</b>				
1	PIPE BURSTING 20" HDPE (DR 19)	L.F.	148.00	
2	8" PVC PIPE	L.F.	516.00	
3	24" PVC PIPE	L.F.	2,018.00	
4	STEEL ENCASEMENT PIPE	L.F.	70.00	
5	TRENCH EXCAVATION	L.F.	2,534.00	
6	STANDARD BEDDING MATERIAL	C.Y.	1,460.00	
7	CONSTRUCT 4' DIAMETER MANHOLE	(5) EA.	2.00	
8	EXTRA DEPTH 4' DIAMETER MANHOLE	V.F.	6.00	
9	CONSTRUCT 5' DIAMETER MANHOLE	(5) EA.	7.00	
10	EXTRA DEPTH 5' DIAMETER MANHOLE	V.F.	67.00	
11	MANHOLE FRAME AND LID	EA.	7.00	
12	SANITARY SEWER MANHOLE REHABILITATION (5' DIAMETER)	(5)(6) V.F.	28.00	
13	REMOVE & REPLACE SIDEWALK/TRAIL	S.Y.	197.00	
14	SAWING PAVEMENT	L.F.	92.00	
15	CONSTRUCTION SIGNING & TRAFFIC CONTROL	(8) L.S.	1.00	
16	MOBILIZATION/DEMOBILIZATION	(3) L.S.	1.00	
17	SOLID SLAB SODDING	(1) S.Y.	4,367.00	
18	RIP RAP	S.Y.	158.00	
19	CLASS A CONCRETE	C.Y.	98.00	
20	REINFORCING STEEL	LB.	853.00	
21	SEWER SERVICE CONNECTIONS	EA.	3.00	
22	SEWER SERVICE LINE	L.F.	100.00	
23	SILT FENCE	L.F.	2,375.00	
24	ABANDON SEWER	C.Y.	20.00	
25	ABANDON MANHOLE	EA.	5.00	
26	DEFLECTION TEST	L.S.	1.00	
27	SEWER FLOW CONTROL	(7) L.S.	1.00	
28	LEAKAGE TEST	L.S.	1.00	
29	PRE-CONSTRUCTION TELEVISION INSPECTION (CCTV) & CLEANING	(4) L.F.	148.00	
30	POST-CONSTRUCTION TELEVISION INSPECTION	(4) L.F.	148.00	

SUMMARY OF PAY QUANTITIES - SANITARY SEWER				
NO.	DESCRIPTION	UNIT	QUANTITY	AS-BUILT
<b>ADD. ALT #1</b>				
1	PIPE BURSTING 26" HDPE (DR 19)	L.F.	1,789.00	
2	CONSTRUCT 5' DIAMETER MANHOLE	(5) EA.	5.00	
3	EXTRA DEPTH 5' DIAMETER MANHOLE	V.F.	33.00	
4	MANHOLE FRAME AND LID	EA.	5.00	
5	SANITARY SEWER MANHOLE REHABILITATION (5' DIAMETER)	(5)(6) V.F.	55.00	
6	POINT REPAIR	(2) L.F.	100.00	
7	REMOVE & REPLACE SIDEWALK/TRAIL	S.Y.	83.00	
8	SAWING PAVEMENT	L.F.	16.00	
9	CONSTRUCTION SIGNING & TRAFFIC CONTROL	(8) L.S.	1.00	
10	MOBILIZATION/DEMOBILIZATION	(3) L.S.	1.00	
11	SOLID SLAB SODDING	(1) S.Y.	117.00	
12	SILT FENCE	L.F.	70.00	
13	SEWER FLOW CONTROL	(7) L.S.	1.00	
14	LEAKAGE TEST	L.S.	1.00	
15	PRE-CONSTRUCTION TELEVISION INSPECTION (CCTV) & CLEANING	(4) L.F.	1,789.00	
16	POST-CONSTRUCTION TELEVISION INSPECTION	(4) L.F.	1,789.00	

SUMMARY OF PAY QUANTITIES - SANITARY SEWER				
NO.	DESCRIPTION	UNIT	QUANTITY	AS-BUILT
<b>ADD. ALT. #2</b>				
1	PIPE BURSTING 26" HDPE (DR 19)	L.F.	2,374.00	
2	CONSTRUCT 5' DIAMETER MANHOLE	(5) EA.	7.00	
3	EXTRA DEPTH 5' DIAMETER MANHOLE	V.F.	40.00	
4	MANHOLE FRAME AND LID	EA.	7.00	
5	SANITARY SEWER MANHOLE REHABILITATION (5' DIAMETER)	(5)(6) V.F.	71.00	
6	POINT REPAIR	(2) L.F.	100.00	
7	8" CONCRETE DRIVEWAY (H.E.S.)	S.Y.	80.00	
8	REMOVE & REPLACE SIDEWALK/TRAIL	S.Y.	239.00	
9	SAWING PAVEMENT	L.F.	200.00	
10	CONSTRUCTION SIGNING & TRAFFIC CONTROL	(8) L.S.	1.00	
11	MOBILIZATION/DEMOBILIZATION	(3) L.S.	1.00	
12	SEWER FLOW CONTROL	(7) L.S.	1.00	
13	LEAKAGE TEST	L.S.	1.00	
14	PRE-CONSTRUCTION TELEVISION INSPECTION (CCTV) & CLEANING	(4) L.F.	2,374.00	
15	POST-CONSTRUCTION TELEVISION INSPECTION	(4) L.F.	2,374.00	

**PAY ITEM NOTES:**

- COST TO INCLUDE ALL SOD REQUIRED TO REPAIR ALL DISTURBED AREAS. REPLACEMENT SOD SHALL BE LIKE KIND (BERMUDA OR FESCUE) OF EXISTING CONDITIONS.
  - ALL POINT REPAIRS WILL INCLUDE NECESSARY PIPE, FITTINGS, APPURTENCES, EXCAVATION AND BACKFILL REQUIRED TO REPAIR BROKEN SEWER LINE THAT CAN NOT BE REPAIRED BY TRENCHLESS REHABILITATION.
  - PRE-CONSTRUCTION TELEVISION INSPECTION SHALL BE COMPLETED FOR THE ENTIRE PROJECT LENGTH PRIOR TO ANY CONSTRUCTION ACTIVITIES.
  - CONTRACTOR SHALL CONDUCT VIDEO INSPECTION PRIOR TO CONSTRUCTION AND POST CONSTRUCTION FOR ALL PIPE TO BE REHABILITATED. THREE COPIES OF POST CONSTRUCTION VIDEO SHALL BE PROVIDED TO THE OWNER.
  - CONTRACTOR TO RECONNECT ALL EXISTING SANITARY SEWER CONNECTIONS AND PROVIDE ALL NECESSARY HDPE OR PVC (SDR 26) PIPING TO COMPLETE THE CONNECTION.
  - CONTRACTOR TO REHABILITATE MANHOLES AS DESIGNATED ON THE DRAWINGS. REHABILITATION METHOD SHALL USE A CEMENTITIOUS MATERIAL AND APPLIED TO A THICKNESS OF 1/2 INCH. STRONG SEAL MS-2C OR APPROVED EQUAL.
  - ALL FLOW CONTROL EQUIPMENT, HOSES, AND OTHER DEVICES SHALL BE FREE OF ANY LEAKS, AND INSPECTED DAILY FOR THE PRESENCE OF NEW LEAKS. LEAKING EQUIPMENT SHALL BE REPAIRED OR REPLACED IMMEDIATELY.
  - TRAFFIC CONTROL PLANS MUST BE SUBMITTED TO THE CITY OF MOORE TRAFFIC ENGINEER FOR APPROVAL PRIOR TO ANY LANE OR STREET CLOSURES. NOTICE OF LANE OR STREET CLOSURES MUST BE PROVIDED TO THE CITY OF MOORE ONE (1) WEEK PRIOR TO CLOSURE.
- ALL SIGNS, BARRICADES, WARNING LIGHTS AND OTHER TRAFFIC CONTROL DEVICES USED FOR CONSTRUCTION TRAFFIC CONTROL SHALL MEET THE REQUIREMENTS OF THE LATEST EDITION OF THE MANUAL ON UNIFORM TRAFFIC CONTROL DEVICES FOR STREETS AND HIGHWAYS AS PERTAINS TO SHAPE, SIZE, COLOR, MOUNTING HEIGHT, AND PLACEMENT.

**GENERAL CONSTRUCTION NOTES:**

- ALL WORK PERFORMED AND MATERIALS SUPPLIED SHALL CONFORM TO THE PLANS AND/OR PROJECT SPECIFICATIONS. ANY WORK NOT COVERED IN THE PLANS OR SPECIFICATIONS SHALL CONFORM TO THE CITY OF MOORE'S "STANDARD SPECIFICATIONS AND CONSTRUCTION DRAWINGS" OR THE "STANDARD SPECIFICATIONS FOR HIGHWAY CONSTRUCTION, OKLAHOMA DEPARTMENT OF TRANSPORTATION, EDITION OF 2009" AND SUPPLEMENTALS
- THE CONTRACTOR SHALL BE RESPONSIBLE FOR NOTIFYING ALL UTILITY COMPANIES AND GOVERNMENTAL AGENCIES WHO MIGHT HAVE UTILITY LINES ON OR ABOUT THE PREMISES, OR WHO MIGHT BE AFFECTED BY THE CONSTRUCTION. THE CONTRACTOR SHALL ALSO COORDINATE THEIR ACTIVITIES WITH THE UTILITY COMPANIES TO ENSURE COMPLIANCE WITH THE PROJECT SCHEDULE. THE CONTRACTOR SHALL MAKE EVERY EFFORT TO PROTECT EXISTING UTILITY LINES, AND SHALL REPAIR ANY DAMAGES AT THEIR OWN EXPENSE.
- UNLESS OTHERWISE SPECIFIED, THE CONTRACTOR SHALL BE RESPONSIBLE FOR THEIR OWN CONSTRUCTION STAKING.
- THE CONTRACTOR SHALL BE RESPONSIBLE FOR ERECTING AND MAINTAINING BARRICADES AND OTHER TRAFFIC WARNING DEVICES AS NECESSARY AROUND THE PERIMETER OF CONSTRUCTION AND ADJACENT TO ANY OPEN TRENCHES.
- ALL VALVE BOXES, MANHOLE LIDS, AND SEWER CLEAN-OUTS LOCATED IN PAVED AREAS, SHALL BE H-20 TRAFFIC RATED.
- THE CONTRACTOR SHALL BE RESPONSIBLE FOR VERIFYING ELEVATIONS AND ADJUSTING ALL COVERS AND LIDS IN PAVED AREAS TO FINISHED GRADE. ALL FIELD ADJUSTMENTS SHALL BE NOTED AND BROUGHT TO THE ENGINEER'S ATTENTION FOR APPROVAL.
- CONTRACTOR SHALL FIELD VERIFY AND REPORT TO THE ENGINEER ALL EXISTING UTILITIES ELEVATIONS THAT CROSS OR CONFLICT WITH PROPOSED CONSTRUCTION PRIOR TO BEGINNING ANY WORK.
- CONTACT UTILITY PROVIDERS AND OWNER 48 HOURS PRIOR TO CONNECTION TO EXISTING UTILITY LINES.
- UTILITY CONTRACTORS MUST VISIT THE SITE AND BE FAMILIAR WITH ALL EXISTING CONDITIONS PRIOR TO PROVIDING A BID.
- CONTRACTOR SHALL SOLELY BE RESPONSIBLE FOR ALL REQUIRED TRENCH SHORING.



  
**Cabbiness Engineering, Inc.**  
 333 12th Avenue SE, Suite 200  
 Okemune, Oklahoma 73165  
 www.CabbinessEngineering.com  
Certificate of Authorization No. CA-4747 Expires June 30, 2016

NO.	DATE	REVISION DESCRIPTION

PROJ.: 251  
 DATE: 1/16/2017  
 DRAWN BY: DH  
 DESIGNED BY: AMW  
 CHECKED BY: JBC

**LITTLE RIVER PARK SANITARY SEWER INTERCEPTOR**  
 CITY OF MOORE  
 QUANTITIES AND LOCATION MAP

SCALE:  
 1" = 300'

SHEET  
 2

PROJECT NO.  
 I-03-W-LMA



U:\Projects\251 - Moore CDBG Sewer Interceptor\I-03-W-LMA\DWG\251-SUMMARIES.dwg Helen/2/13/2017 4:10 PM

### Summary of Structures

Structure No.	Sheet No.	Station	Description	Top of Rim or Top of Grate	Flowlines			Rehab. Existing MH	Const. 4' Dia MH	Const. 5' Dia MH	Additional Depth 4' Dia MH	Additional Depth 5' Dia MH		
					Elev.	FL In	FL In						FL Out	V.F.
<b>ADD. ALT. #2</b>														
1	4	33+82.60	Rehab. Existing 5' Diameter Man Hole	1,195.31	1,182.74		1,182.30	13.01						
2	4	34+05.81	Const. Standard 5' Diameter Man Hole	1,196.88	1,182.79	1,182.83	1,185.59			1.00		8.09		
3	5	36+98.69	Rehab. Existing 5' Diameter Man Hole	1,195.15	1,183.51		1,183.40	11.75						
4	5	38+21.93	Const. Standard 5' Diameter Man Hole	1,196.20	1,185.19	1,192.40	1,185.03			1.00		5.17		
5	5	41.60.55	Const. Standard 5' Diameter Man Hole	1,197.00	1,186.82	1,185.91	1,185.85			1.00		5.15		
6	5	43+22.40	Rehab. Existing 5' Diameter Man Hole	1,196.83	1,192.25	1,186.61	1,186.58	10.25						
7	6	45+18.61	Const. Standard 5' Diameter Man Hole	1,198.00	1,194.18	1,187.91	1,187.23			1.00		4.77		
7A	6	47+82.22	Const. Standard 5' Diameter Man Hole	1,198.90	1,187.91		1,187.91			1.00		4.99		
8	6	50+73.19	Rehab. Existing 5' Diameter Man Hole	1,200.45	1,188.70		1,188.67	11.78						
9	6	51+59.19	Rehab. Existing 5' Diameter Man Hole	1,200.90	1,190.58	1,189.06	1,189.00	11.90						
10	6	52+71.93	Const. Standard 5' Diameter Man Hole	1,201.17	1,190.20	1,189.40	1,189.36			1.00		5.81		
11	7	54+42.94	Rehab. Existing 5' Diameter Man Hole	1,201.81	1,190.20		1,190.16	11.65						
12	7	56+13.15	Const. Standard 5' Diameter Man Hole	1,202.10	1,191.21	1,190.31	1,190.21			1.00		5.89		
<b>TOTALS</b>								<b>70.34</b>		<b>7.00</b>		<b>39.87</b>		
<b>ADD. ALT. #1</b>														
13	7	57+55.84	Rehab. Existing 5' Diameter Man Hole	1,202.00	1,190.93		1,190.80	11.20						
14	7	59+09.85	Const. Standard 5' Diameter Man Hole	1,202.43	1,194.09	1,191.53	1,191.47			1.00		4.96		
15	7	61+50.08	Const. Standard 5' Diameter Man Hole	1,203.72	1,193.58	1,192.59	1,192.52			1.00		5.20		
16	8	63+66.60	Rehab. Existing 5' Diameter Man Hole	1,207.76	1,193.20		1,193.16	14.60						
17	8	65+83.49	Const. Standard 5' Diameter Man Hole	1,208.37	1,194.04		1,194.04			1.00		8.33		
18	8	67+00.88	Rehab. Existing 5' Diameter Man Hole	1,209.22	1,195.81	1,194.36	1,194.36	14.86						
19	8	69+89.45	Const. Standard 5' Diameter Man Hole	1,208.08	1,198.94	1,195.32	1,195.32			1.00		6.76		
20	9	71+61.24	Rehab. Existing 5' Diameter Man Hole	1,211.35	1,197.78		1,197.75	13.60						
21	9	75+44.45	Const. Standard 5' Diameter Man Hole	1,211.73	1,198.47		1,198.43			1.00		7.30		
<b>TOTALS</b>								<b>54.26</b>		<b>5.00</b>		<b>32.55</b>		
<b>BASE BID</b>														
21A	9	75+64.45	Const. Standard 5' Diameter Man Hole	1,211.52	1,198.62		1,198.52			1.00		7.00		
22	9	78+99.74	Const. Standard 5' Diameter Man Hole	1,214.22	1,199.32		1,199.22			1.00		9.00		
23	10	83+13.67	Const. Standard 5' Diameter Man Hole	1,220.68	1,200.44		1,200.34			1.00		14.34		
23A	10	86+88.99	Const. Standard 5' Diameter Man Hole	1,219.18	1,200.60		1,200.70			1.00		12.48		
24	11	90+08.01	Const. Standard 5' Diameter Man Hole	1,214.56	1,201.50		1,201.30			1.00		7.26		
24A	11	93+00.00	Const. Standard 5' Diameter Man Hole	1,216.17	1,202.02		1,202.02			1.00		8.15		
25	11	94+26.93	Const. Standard 5' Diameter Man Hole	1,216.85	1,202.09		1,202.19			1.00		8.66		
26	11	95+61.78	Rehab. Existing 5' Diameter Man Hole	1,217.59	1,204.00	1,203.47	1,202.58	15.01						
27	11	96+65.59	Rehab. Existing 5' Diameter Man Hole	1,215.88	1,203.59	1,203.51	1,203.43	12.45						
28	12	0+57.34	Const. Standard 4' Diameter Man Hole	1,215.49	1,204.35		1,204.25			1.00		5.24		
29	12	5+15.99	Const. Standard 4' Diameter Man Hole	1,211.50			1,206.25			1.00				
<b>TOTALS</b>								<b>27.46</b>		<b>2.00</b>		<b>7.00</b>	<b>5.24</b>	<b>66.89</b>

### Summary of Pavement Repair

Sheet No.	Approximate Station	Remove Concrete Sidewalk	Remove Concrete Paving	4" Concrete Sidewalk	8" Concrete Driveway (H.E.S.)	Sawing Pavement
		S.Y.	S.Y.	S.Y.	S.Y.	L.F.
<b>ADD. ALT. #2</b>						
4	33+50	5.00		5.00	0.00	10.00
5	37+00	3.00	35.00	3.00	35.00	58.00
5	37+77		45.00		45.00	100.00
6	50+73	49.00		49.00		
6	52+70	100.00		100.00	0.00	16.00
7	56+00	82.00		82.00	0.00	16.00
<b>TOTALS</b>		<b>239.00</b>	<b>80.00</b>	<b>239.00</b>	<b>80.00</b>	<b>200.00</b>
<b>ADD. ALT. #1</b>						
7	61+00	70.00		70.00	0.00	16.00
9	71+60	13.00		13.00		
<b>TOTALS</b>		<b>83.00</b>	<b>0.00</b>	<b>83.00</b>	<b>0.00</b>	<b>16.00</b>
<b>BASE BID</b>						
10	85+50	81.00		81.00	0.00	32.00
10	86+40	27.00		27.00	0.00	12.00
10	88+50	38.00		38.00	0.00	20.00
11	89+00	13.00		13.00	0.00	12.00
11	89+30	38.00		38.00	0.00	16.00
<b>TOTALS</b>		<b>197.00</b>	<b>0.00</b>	<b>197.00</b>	<b>0.00</b>	<b>92.00</b>

### Summary of Pipe

Sheet No.	Station Extents	Pipe Bursting HDPE		Standard Bedding Material	PVC Pipe (SDR 26)		Trench Excavation
		26"	20"		8"	24"	
		L.F.	L.F.	C.Y.	L.F.	L.F.	L.F.
<b>ADD. ALT. #2</b>							
4	33+82.60 TO 35+00.00	23.21					
5	35+00.00 TO 44+00.00	916.60					
6	44+00.00 TO 53+00.00	949.53					
7	53+00.00 TO 57+52.93	483.90					
<b>TOTALS</b>		<b>2,373.24</b>	<b>0.00</b>	<b>0.00</b>	<b>0.00</b>	<b>0.00</b>	<b>0.00</b>
<b>ADD. ALT. #1</b>							
7	57+52.93 TO 62+00.00	394.32					
8	62+00.00 TO 71+00.00	1,011.16					
9	71+00.00 TO 75+62.03	383.21					
<b>TOTALS</b>		<b>1,788.69</b>	<b>0.00</b>	<b>0.00</b>	<b>0.00</b>	<b>0.00</b>	<b>0.00</b>
<b>BASE BID</b>							
9	75+62.03 TO 80+00.00			236.86	355.29	355.29	
10	80+00.00 TO 89+00.00			738.84	1,108.26	1,108.26	
11	89+00.00 TO 98+00.00		147.84	369.18	553.77	553.77	
12	0+00.00 TO 5+15.99			114.67	516.00	516.00	
<b>TOTALS</b>		<b>0.00</b>	<b>147.84</b>	<b>1,459.55</b>	<b>516.00</b>	<b>2,017.32</b>	<b>2,533.32</b>

### Summary of Erosion Control

Sheet No.	Station Extents	Length	Width	RIP RAP	Solid Slab Sodding	CLASS A CONCRETE
		L.F.	L.F.	S.Y.	S.Y.	C.Y.
<b>ADD. ALT. #2</b>						
4-7	33+82.60 TO 57+55.84					
<b>TOTAL</b>		<b>0.00</b>	<b>0.00</b>	<b>0.00</b>	<b>0.00</b>	
<b>ADD. ALT. #1</b>						
6-9	57+55.84 TO 75+64.45	70.00	15.00		116.67	
<b>TOTAL</b>		<b>70.00</b>	<b>15.00</b>	<b>0.00</b>	<b>116.67</b>	
<b>BASE BID</b>						
9	75+64.45 TO 80+00.00	441.68	15.00		736.13	
10	80+00.00 TO 89+00.00	1,108.26	15.00		1,847.10	
11	89+00.00 TO 98+00.00	553.77	15.00	158.00	922.95	98.00
12	0+00.00 TO 5+15.99	516.00	15.00		860.00	
<b>TOTAL</b>		<b>2,619.71</b>	<b>60.00</b>	<b>158.00</b>	<b>4,366.18</b>	<b>98.00</b>

### Summary of Temporary Sediment Controls

Sheet No.	Station Extents	Location	Type	Temporary Silt Fence 221(C)	Temporary Sediment filter 221(D)	Temporary Rock Filter Dam Type 4 221(G)
				L.F.	EA	CY
<b>ADD. ALT. #2</b>						
4-7	33+82.60 TO 57+55.84					
<b>TOTALS</b>						
<b>ADD. ALT. #1</b>						
7-9	57+55.84 TO 75+64.45		Lt.	70		
<b>TOTALS</b>				70		
<b>BASE BID</b>						
9	75+64.45 TO 80+00.00		Lt.	441.68		
10	80+00.00 TO 89+00.00		Lt.	893.11		
11	89+00.00 TO 98+00.00		Lt.	518.18		
12	0+00.00 TO 5+15.99		Rt.	521.31		
<b>Totals</b>				<b>2,374.28</b>		

LITTLE RIVER PARK SANITARY SEWER INTERCEPTOR  
CITY OF MOORE  
SUMMARY SHEET

SCALE:  
1" = 300'

SHEET  
3

PROJECT NO.  
I-03-W-LMA

PROJ.: 251  
DATE: 1/16/2017  
DRAWN BY: DJH  
DESIGNED BY: AMW  
CHECKED BY: JBC

NO.	DATE	REVISION	DESCRIPTION

**Cabbiness Engineering, Inc**  
333 12th Avenue SE, Suite 200  
Atlanta, GA 30316  
404.310.4443 Office 404.310.4495 Fax  
www.CabbinessEngineering.com  
Certificate of Registration No. CAEP 1488 Expires June 30, 2018



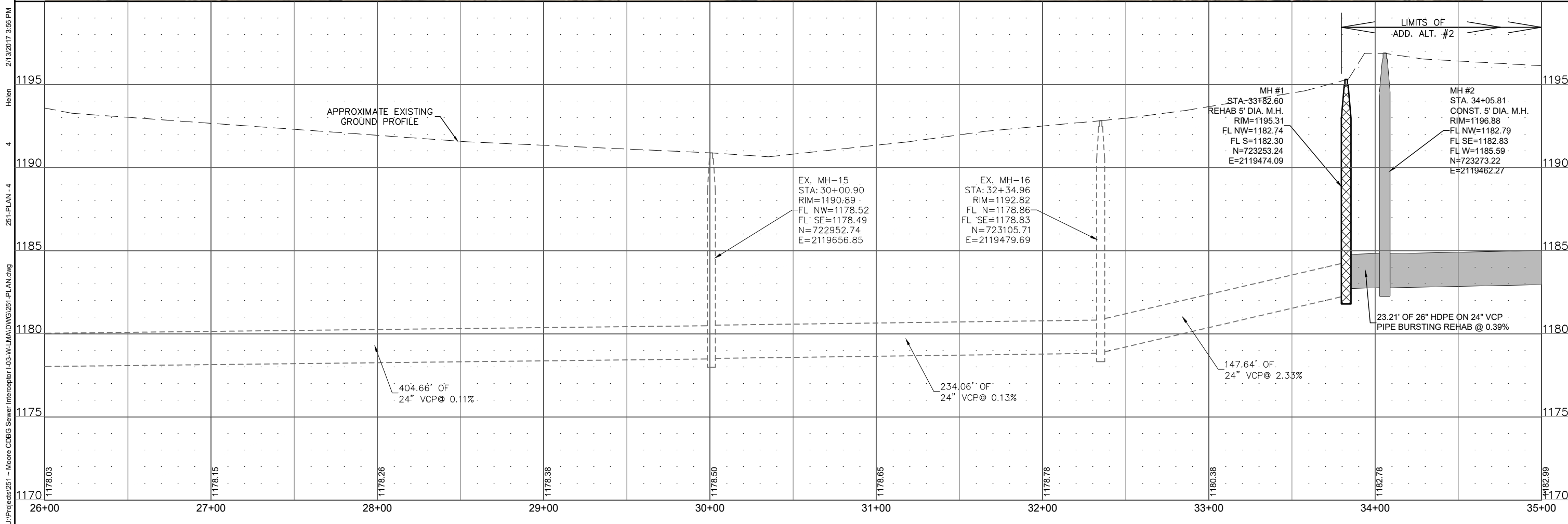
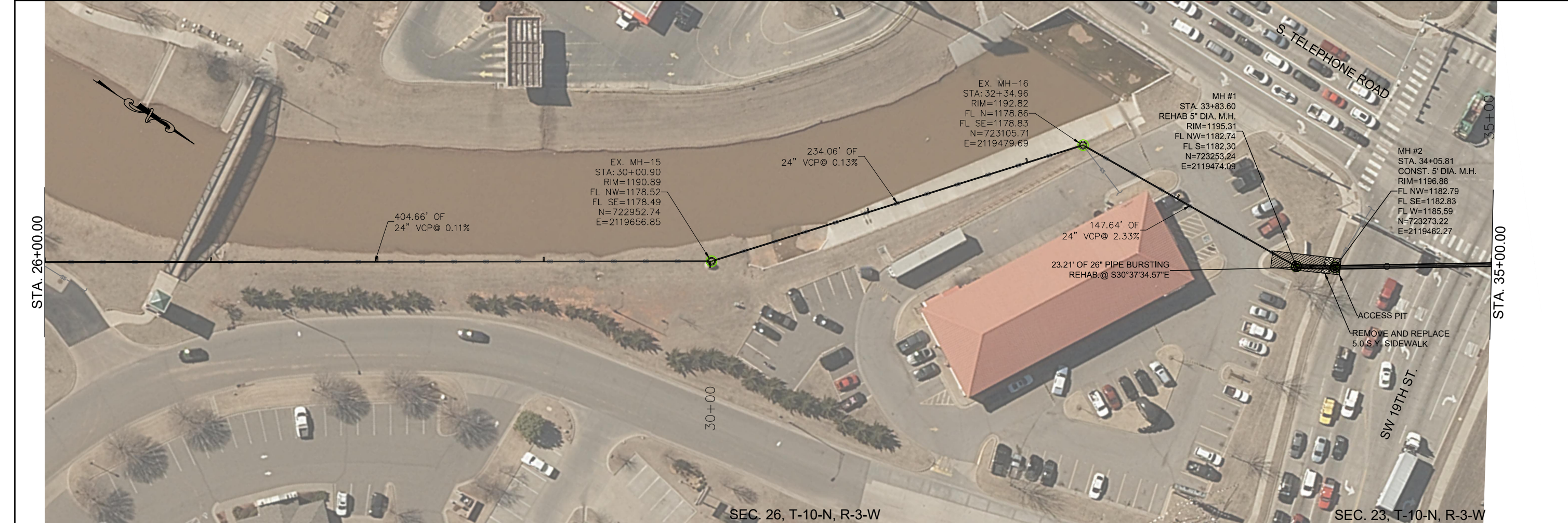

L:\Projects\251 - Moore CDBG Sewer Interceptor\I-03-W-LMA\DWG\251-PLAN.dwg  
 2/13/2017 3:56 PM  
 Helen  
 4  
 251-PLAN-4

NO.	DATE	REVISION DESCRIPTION

PROJ.: 251  
 DATE: 1/16/2017  
 DRAWN BY: DH  
 DESIGNED BY: AMW  
 CHECKED BY: JBC



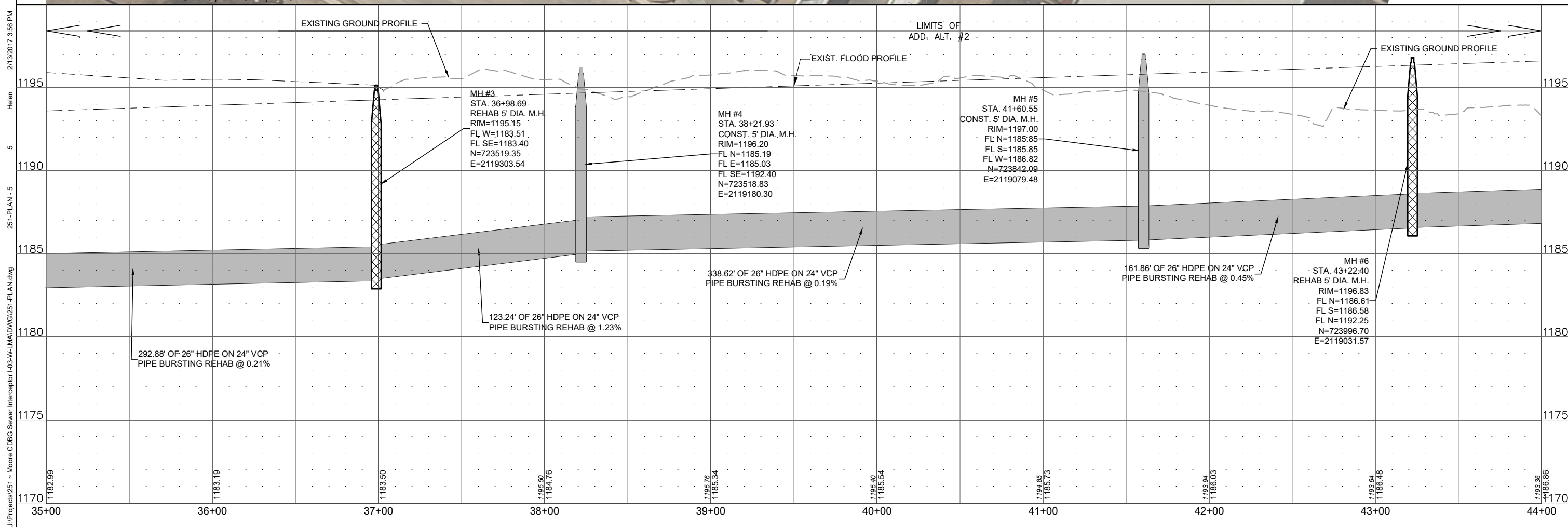

U:\Projects\251 - Moore CDBG Sewer Interceptor\1-03-W-LMA\DWG\251-PLAN.dwg  
 2/13/2017 3:56 PM  
 Helen  
 5  
 251-PLAN - 5

SEC. 22, T-10-N, R-3-W

SEC. 23, T-10-N, R-3-W



**Cabbiness Engineering, Inc.**  
 333 12th Avenue SE, Suite 200  
 Okmulgee, Oklahoma 74450  
 Phone: 405.310.4433  
 Fax: 405.310.4495  
 www.CabbinessEngineering.com

NO.	DATE	REVISION	DESCRIPTION

PROJECT: 251  
 DATE: 1/16/2017  
 DRAWN BY: DH  
 DESIGNED BY: AMW  
 CHECKED BY: JBC

**LITTLE RIVER PARK SANITARY SEWER INTERCEPTOR**  
 CITY OF MOORE  
 PLAN & PROFILE SHEET

SCALE:  
 HOR. 1" = 30'  
 VERT. 1" = 3'

SHEET  
 5

PROJECT NO.  
 1-03-W-LMA



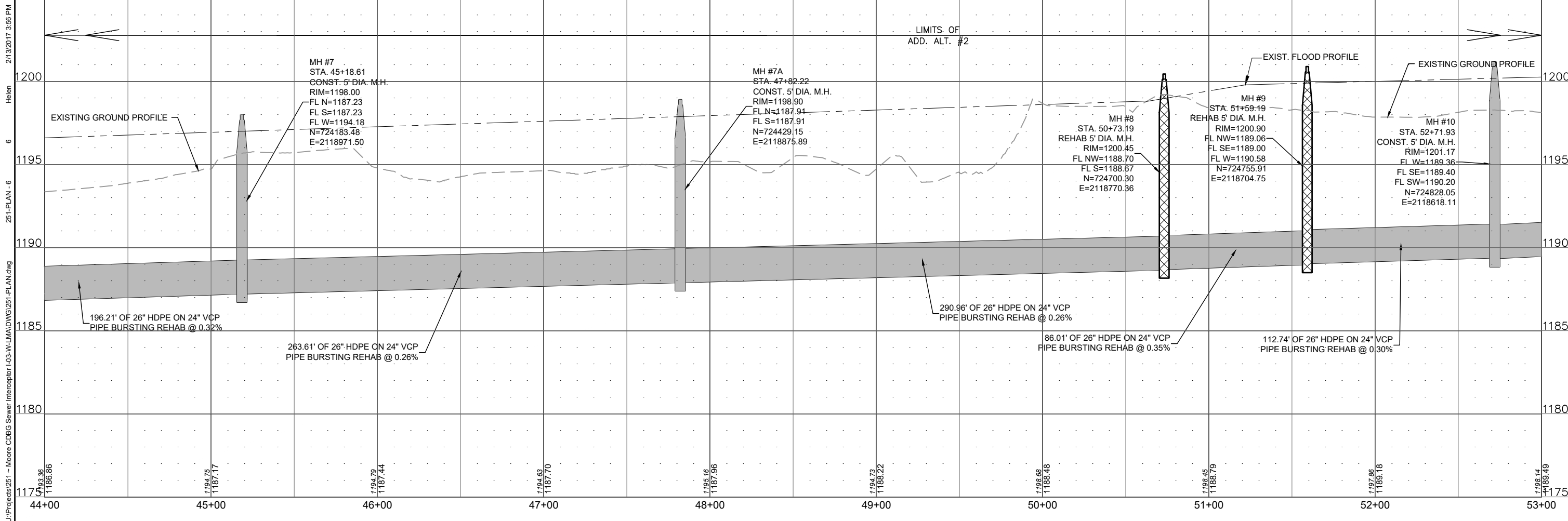
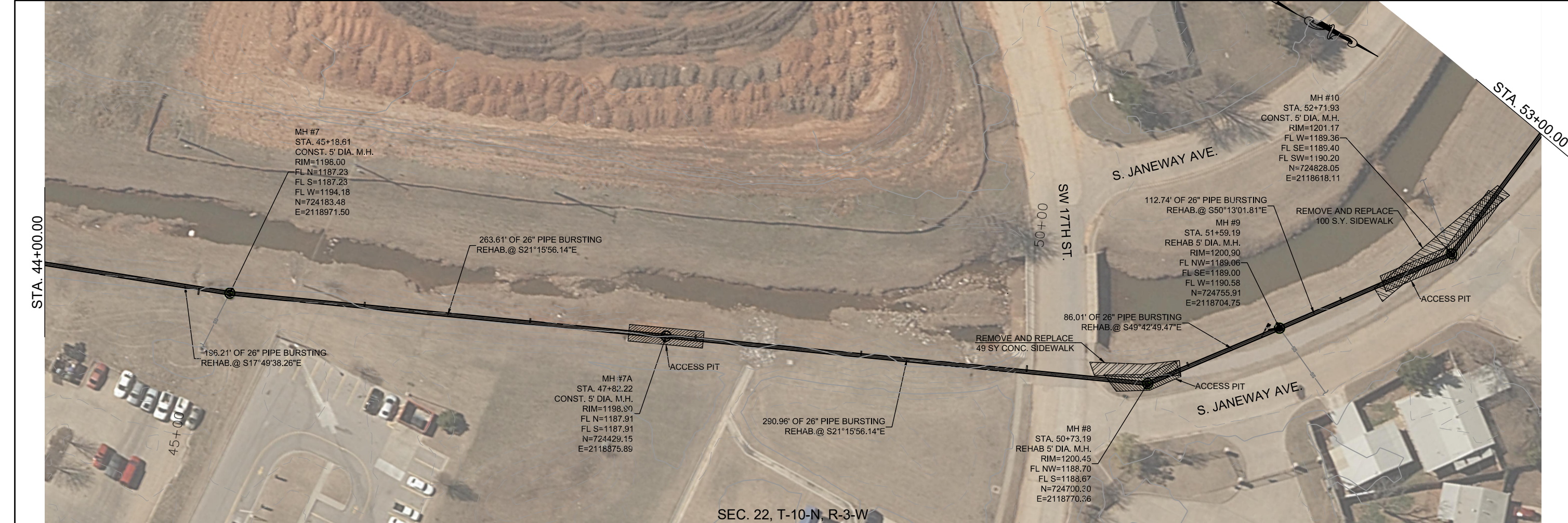

L:\Projects\251 - Moore CDBG Sewer Interceptor\1-03-W-LMA\DWG\251-PLAN.dwg  
 2/13/2017 3:56 PM  
 6  
 251-PLAN-6

NO.	DATE	REVISION DESCRIPTION

PROJ.: 251  
 DATE: 1/16/2017  
 DRAWN BY: DH  
 DESIGNED BY: AMW  
 CHECKED BY: JBC



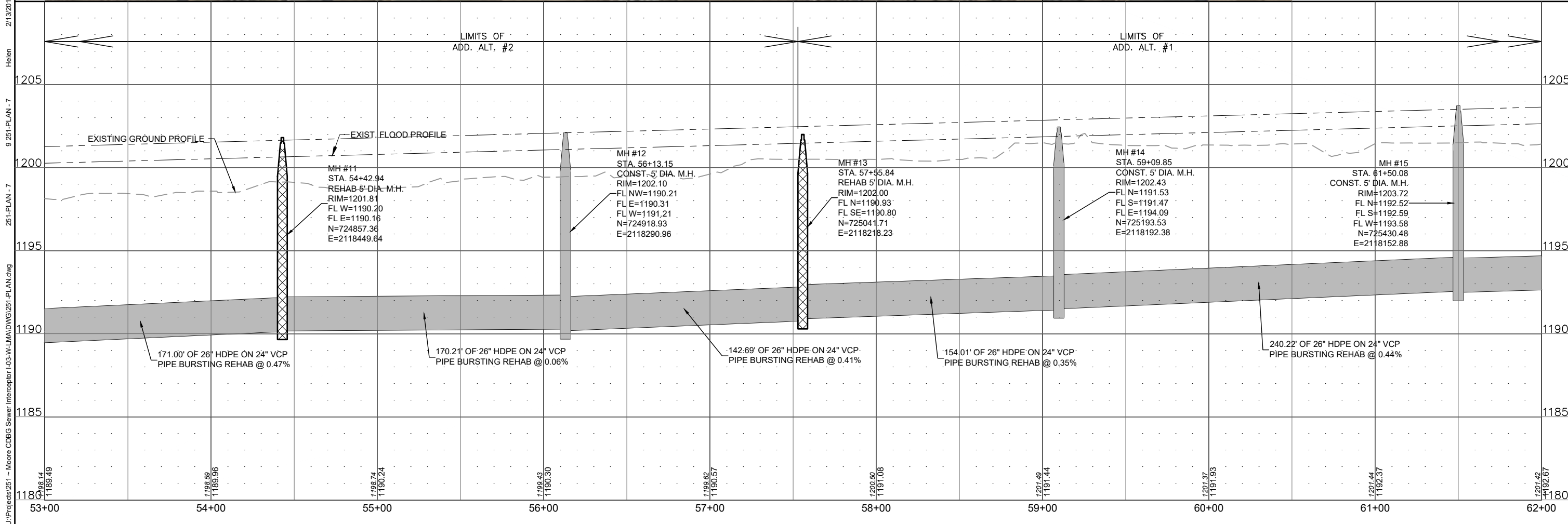
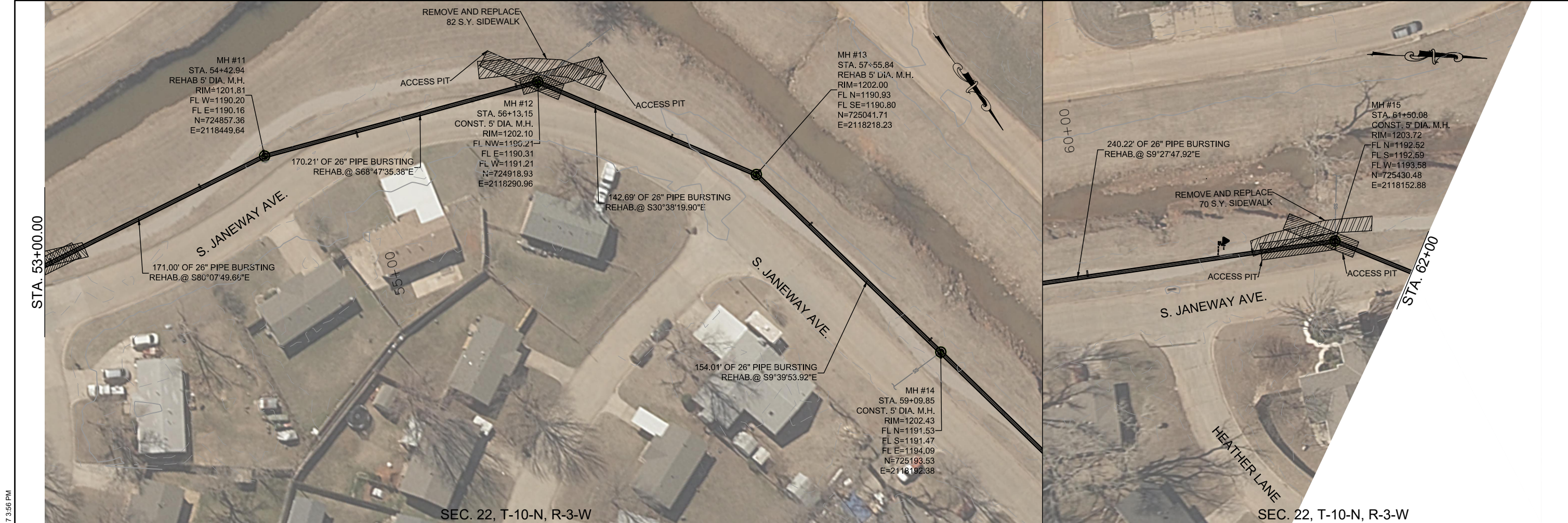

L:\Projects\251 - Moore CDBG Sewer Interceptor\1-03-W-LMA\DWG\251-PLAN.dwg  
 251-PLAN-7  
 9:25:11-PLAN-7  
 Helen 2/13/2017 3:56 PM

NO.	DATE	REVISION DESCRIPTION

PROJ.: 251  
 DATE: 1/16/2017  
 DRAWN BY: DH  
 DESIGNED BY: AMW  
 CHECKED BY: JBC



U:\Projects\251 - Moore CDBG Sewer Interceptor\1-03-W-LMA\DWG\251-PLAN.dwg  
 251-PLAN-8  
 10/25/17-PLAN-8  
 Helen 2/13/2017 3:56 PM



SEC. 22, T-10-N, R-3-W

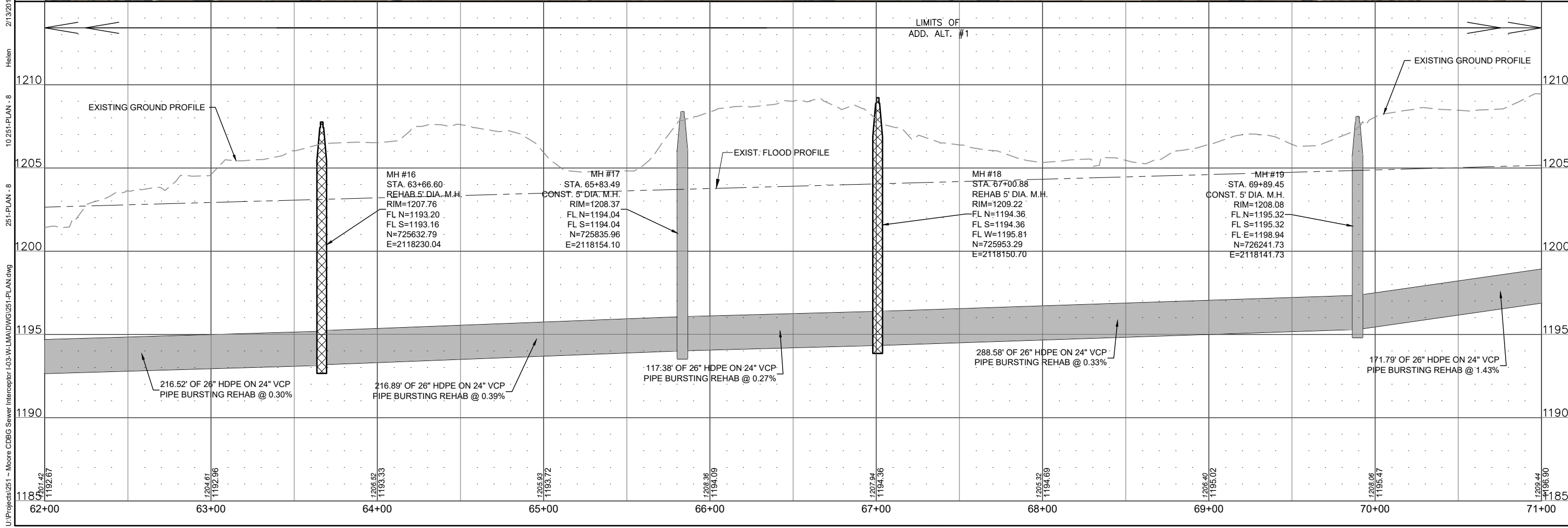

NO.	DATE	REVISION DESCRIPTION

PROJ.: 251  
 DATE: 1/16/2017  
 DRAWN BY: DH  
 DESIGNED BY: AMW  
 CHECKED BY: JBC

**LITTLE RIVER PARK SANITARY SEWER INTERCEPTOR**  
 CITY OF MOORE  
 PLAN & PROFILE SHEET

SCALE:  
 HOR. 1" = 30'  
 VERT. 1" = 3'  
 SHEET  
 8  
 PROJECT NO.  
 1-03-W-LMA



L:\Projects\251 - Moore CDBG Sewer Interceptor\1-03-W-LMA\DWG\251-PLAN.dwg  
 251-PLAN - 9  
 11 251-PLAN - 9  
 Helen 2/13/2017 3:56 PM

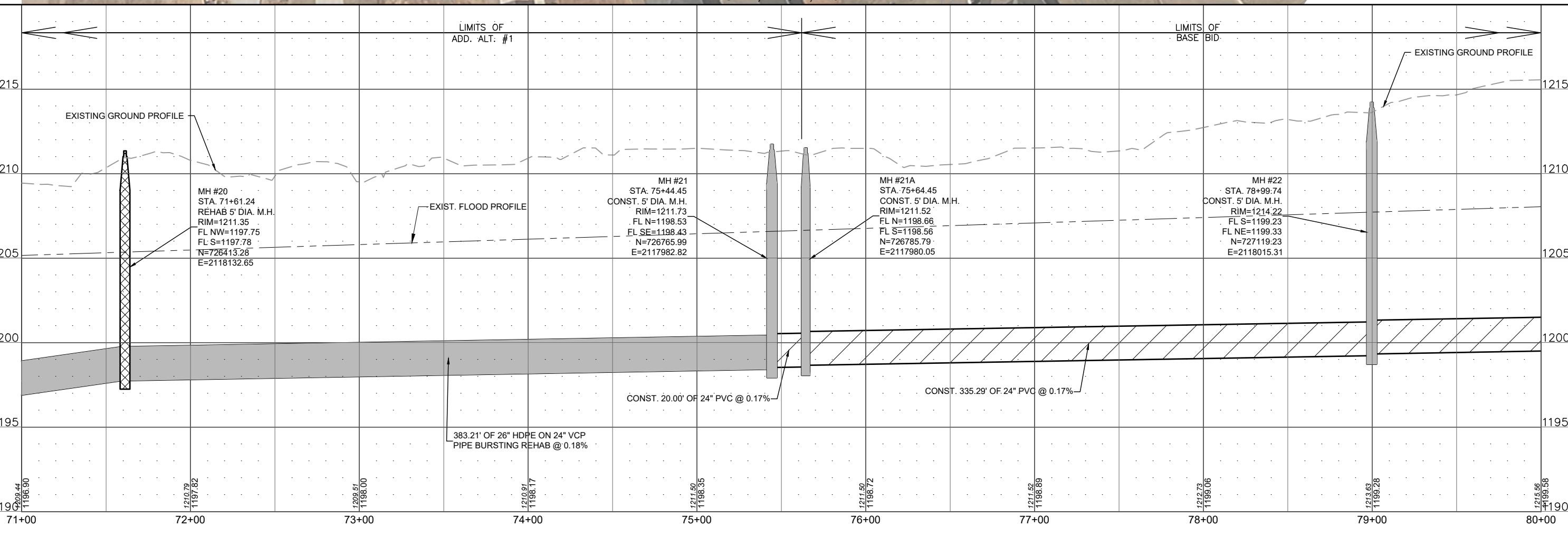
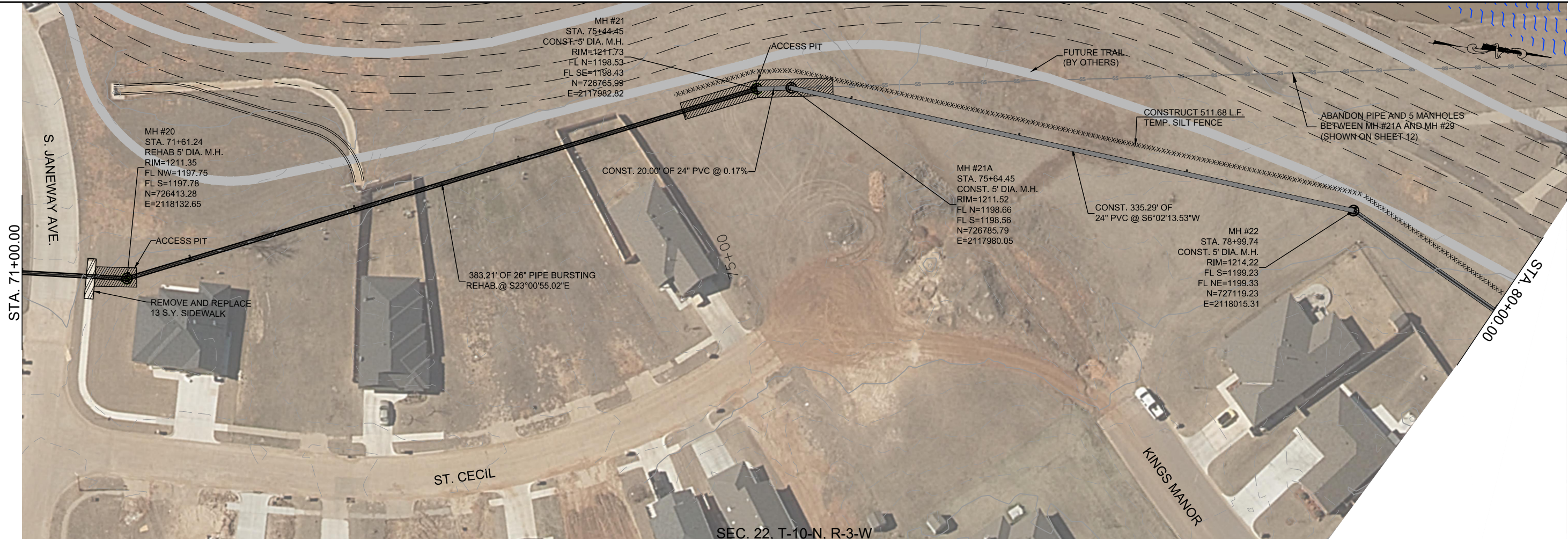

PROJECT NO:  
1-03-W-LMA

SHEET  
9

SCALE:  
HOR. 1" = 30'  
VERT. 1" = 3'

PROJECT: 251

DATE: 1/16/2017

DESIGNED BY: JBC

CHECKED BY: JBC

NO. DATE REVISION DESCRIPTION

BY:

**LITTLE RIVER PARK SANITARY SEWER INTERCEPTOR**  
 CITY OF MOORE  
 PLAN & PROFILE SHEET

**Cabbiness Engineering, Inc.**  
 333 12th Avenue SE, Suite 200  
 Okemune, Oklahoma 74759  
 Phone: 405.310.4433  
 Fax: 405.310.4495  
 www.CabbinessEngineering.com  
 Certificate of Registration No. CA0914 Expires June 30, 2018



L:\Projects\251 - Moore CDBG Sewer Interceptor\1-03-W-LMA\DWG\251-PLAN.dwg  
 2/13/2017 3:56 PM  
 Helen  
 12:25:PLAN-10  
 251-PLAN-10

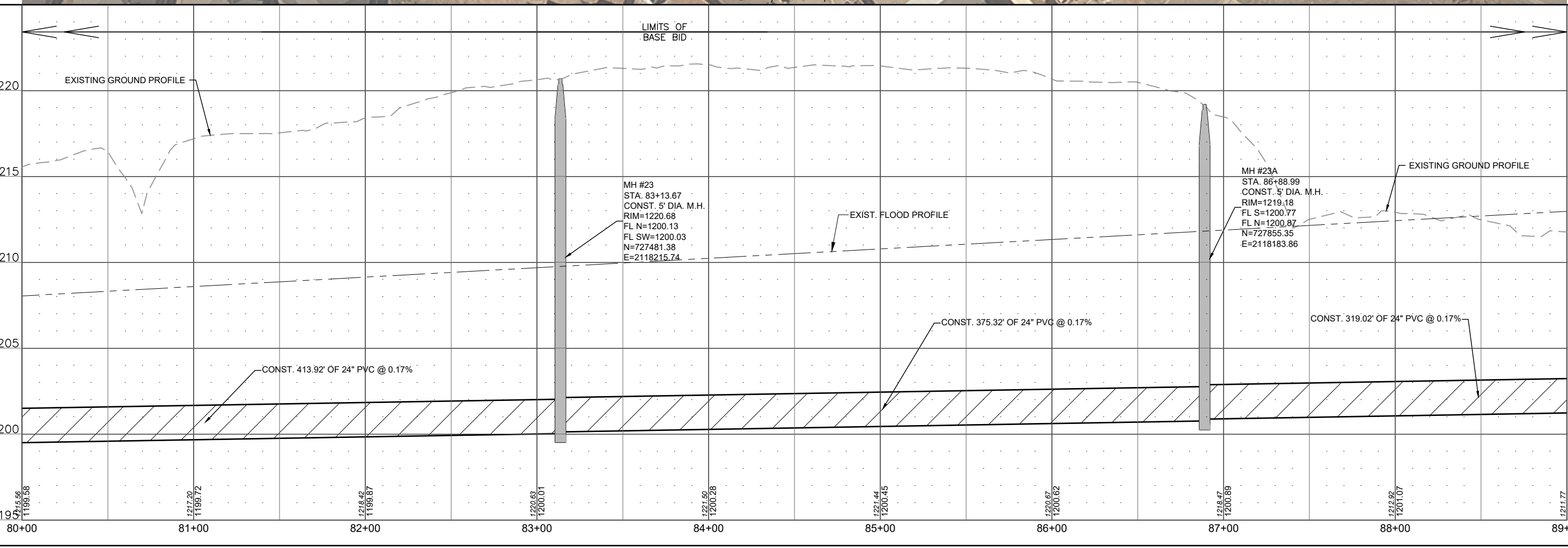

**Cabbiness Engineering, Inc.**  
 333 12th Avenue SE, Suite 200  
 Okemune, Oklahoma 74559  
 Phone: 405.310.4443  
 Fax: 405.310.4495  
 www.CabbinessEngineering.com

NO.	DATE	REVISION DESCRIPTION

PROJ.: 251  
 DATE: 1/16/2017

DRAWN BY: DH  
 DESIGNED BY: AMW  
 CHECKED BY: JBC

LITTLE RIVER PARK SANITARY SEWER INTERCEPTOR  
 CITY OF MOORE  
 PLAN & PROFILE SHEET

SCALE:  
 HOR. 1" = 30'  
 VERT. 1" = 3'

SHEET  
 10

PROJECT NO.  
 1-03-W-LMA



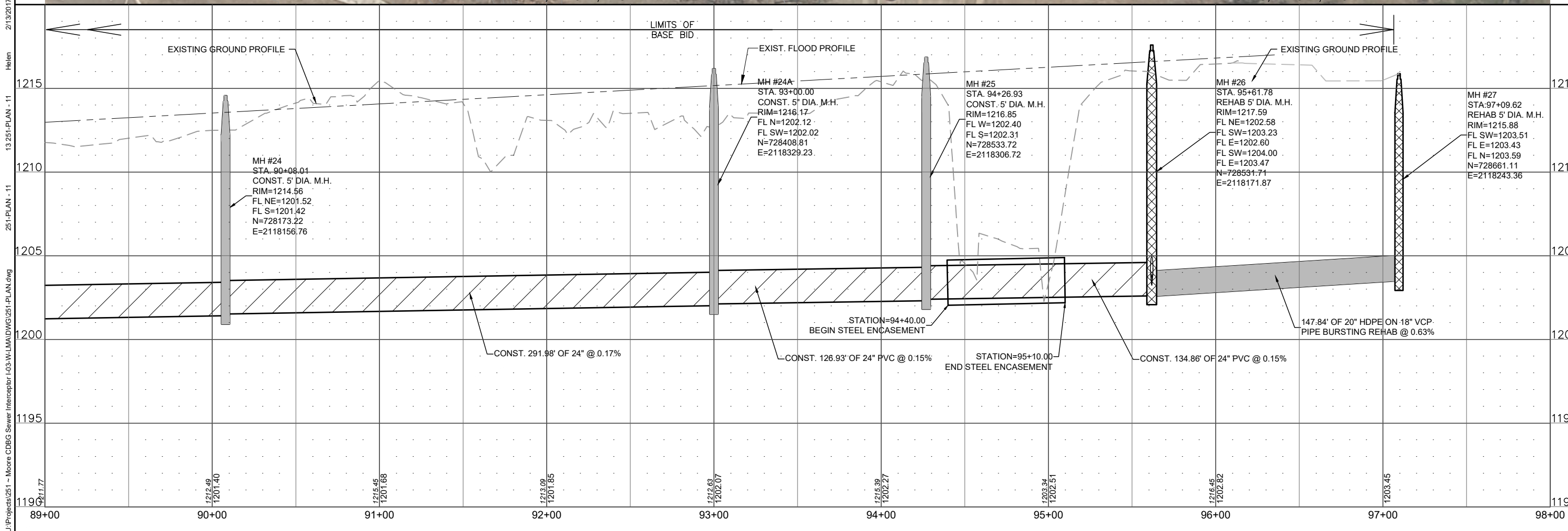
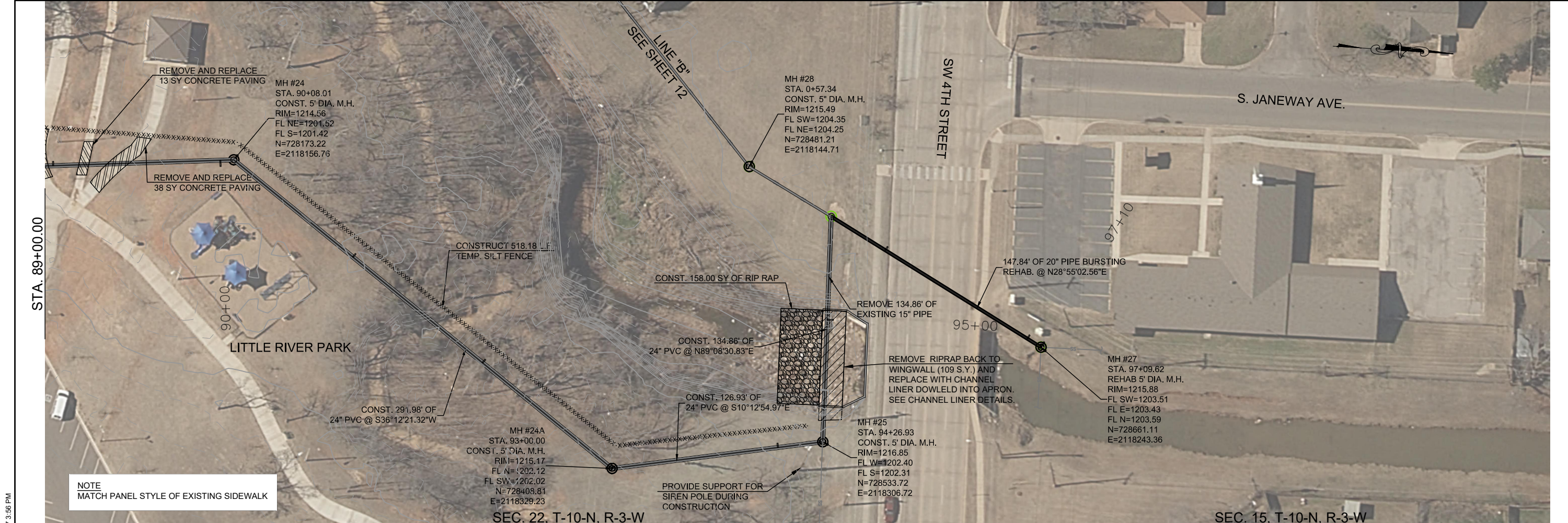

L:\Projects\251 - Moore CDBG Sewer Interceptor\1-03-W-LMA\DWG\351-PLAN.dwg  
 13 251-PLAN - 11  
 251-PLAN - 11  
 Helen 2/13/2017 3:56 PM

**NOTE**  
MATCH PANEL STYLE OF EXISTING SIDEWALK

**LITTLE RIVER PARK SANITARY SEWER INTERCEPTOR**  
CITY OF MOORE  
PLAN & PROFILE SHEET

NO.	DATE	REVISION DESCRIPTION

PROJ: 251  
 DATE: 1/16/2017  
 DRAWN BY: DH  
 DESIGNED BY: AMW  
 CHECKED BY: JBC

SCALE:  
HOR. 1" = 30'  
VERT. 1" = 3'

SHEET  
11

PROJECT NO.  
1-03-W-LMA

**Cabbiness Engineering, Inc**  
 333 12th Avenue SE, Suite 200  
 Okemune, Oklahoma 73169  
 Phone: 405.310.4433  
 Fax: 405.310.4495  
 Email: info@cabbinesseng.com  
 www.CabbinessEngineering.com  
 Certificate of Registration No. CA0914 Expires June 30, 2018



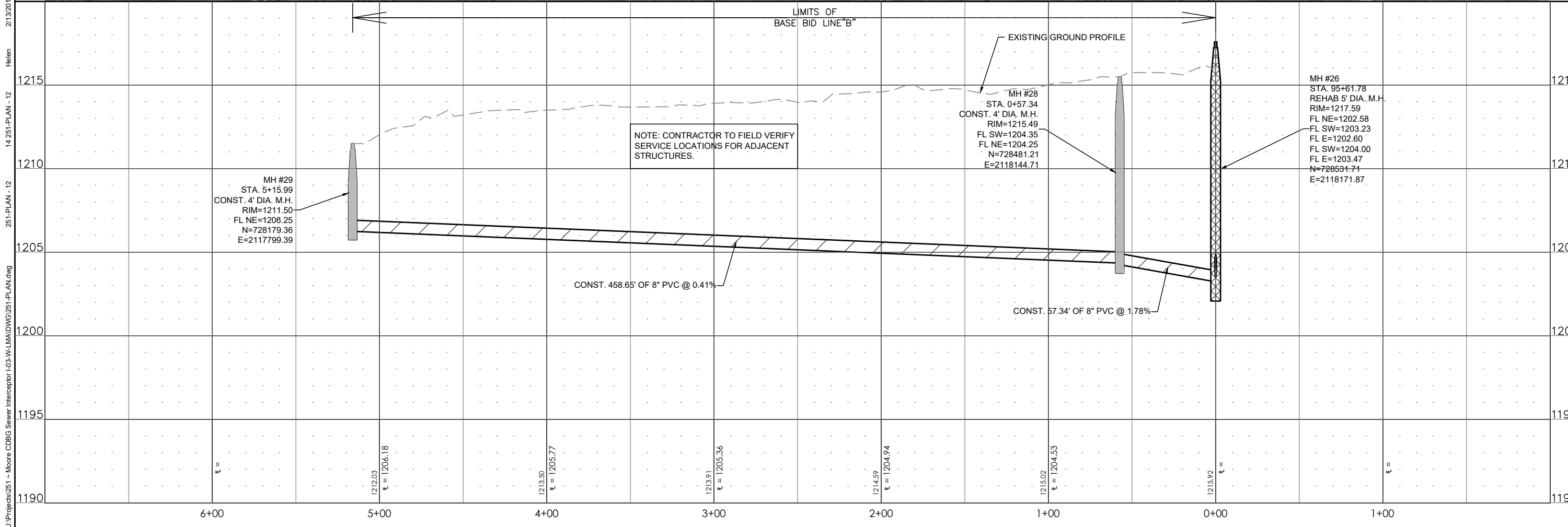
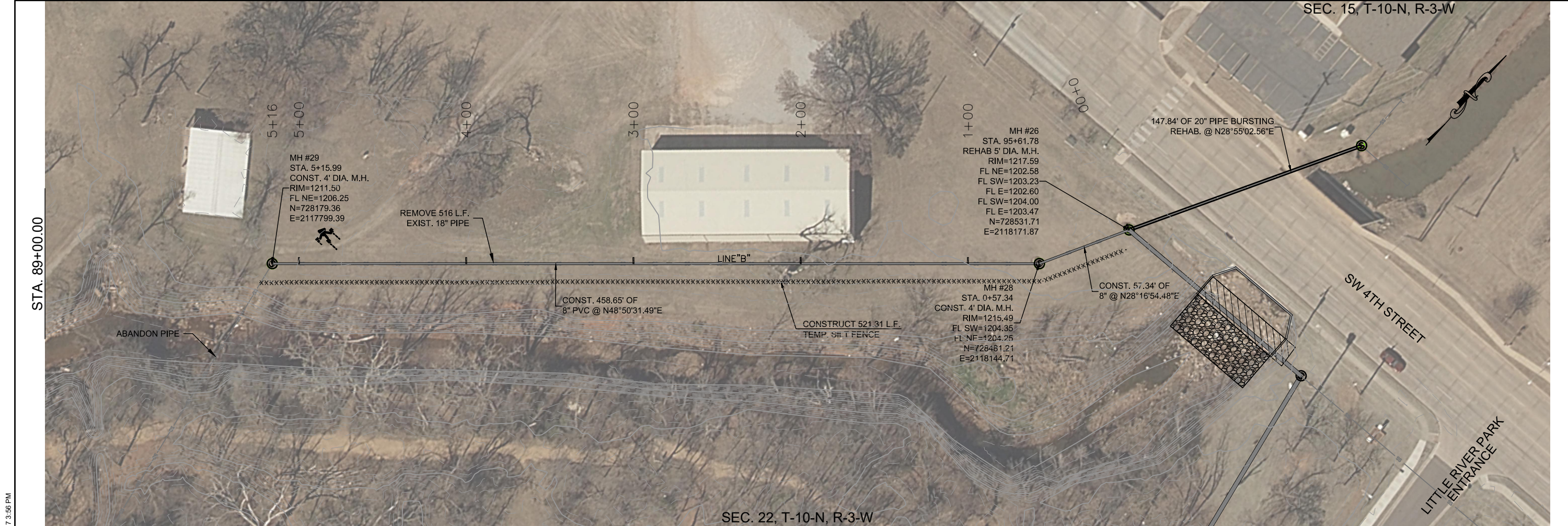

L:\Projects\251 - Moore CDBG Sewer Interceptor\1-03-W-LMA\DWG\251-PLAN.dwg  
 251-PLAN - 12  
 Helen 2/13/2017 3:56 PM

SEC. 15, T-10-N, R-3-W

SEC. 22, T-10-N, R-3-W

PROJECT NO:  
1-03-W-LMA

**LITTLE RIVER PARK SANITARY SEWER INTERCEPTOR**  
CITY OF MOORE  
PLAN & PROFILE SHEET

SCALE:  
HOR. 1" = 30'  
VERT. 1" = 3'

SHEET  
12

PROJECT NO:  
1-03-W-LMA

PROJ.: 251  
DATE: 1/16/2017

DRAWN BY: DH  
DESIGNED BY: AMW  
CHECKED BY: JBC

NO. DATE DESCRIPTION

BY:

REVISION

DESCRIPTION

Cabbiness Engineering, Inc  
333 12th Avenue SE, Suite 200  
Mableton, GA 30143  
404.310.4433 Office 404.310.4495 Fax  
www.CabbinessEngineering.com  
Certificate of Authorization No. CA#974 Expires June 30, 2018



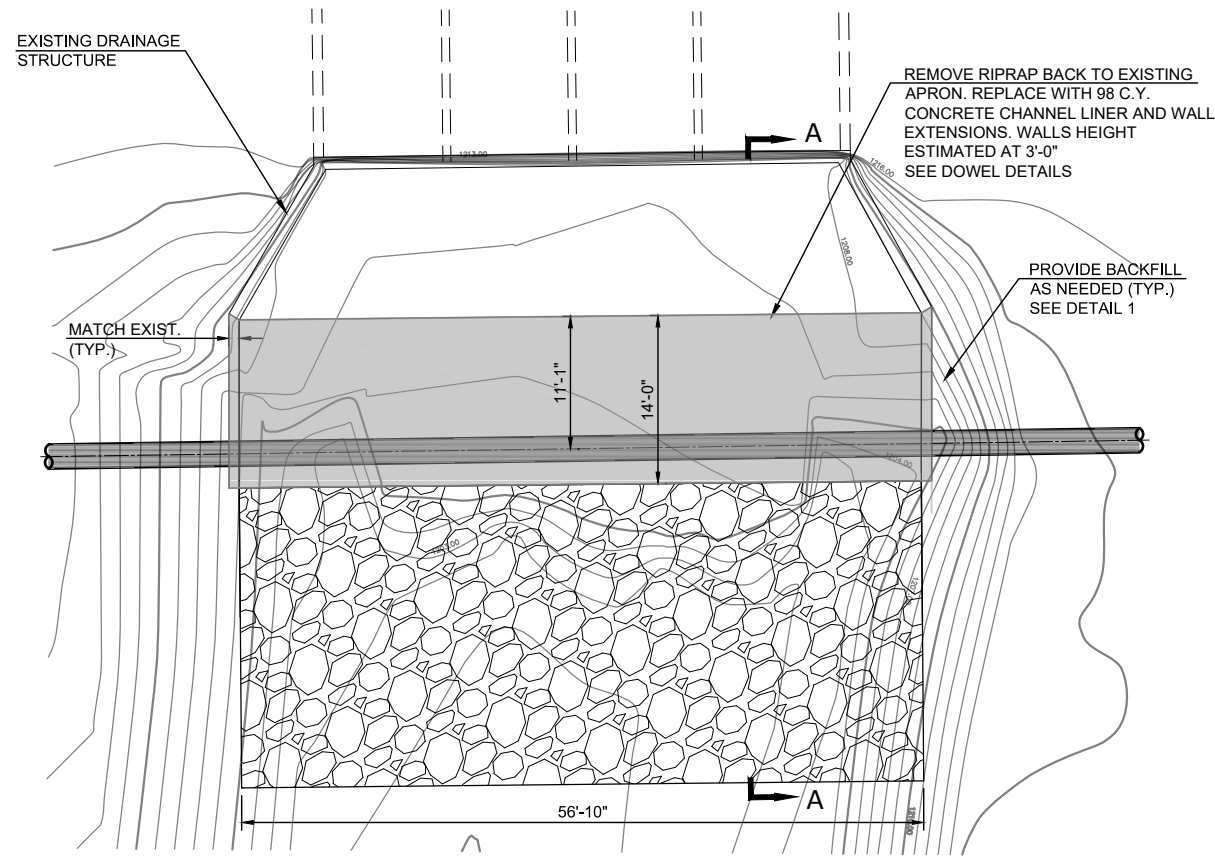

PLAN

NOTE:  
CONTRACTOR TO FIELD VERIFY ALL MEASUREMENTS.

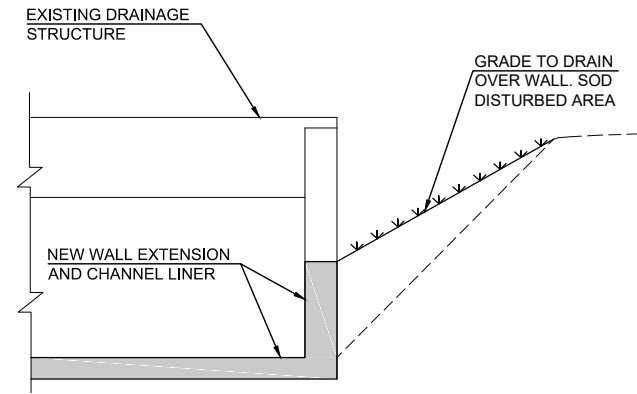
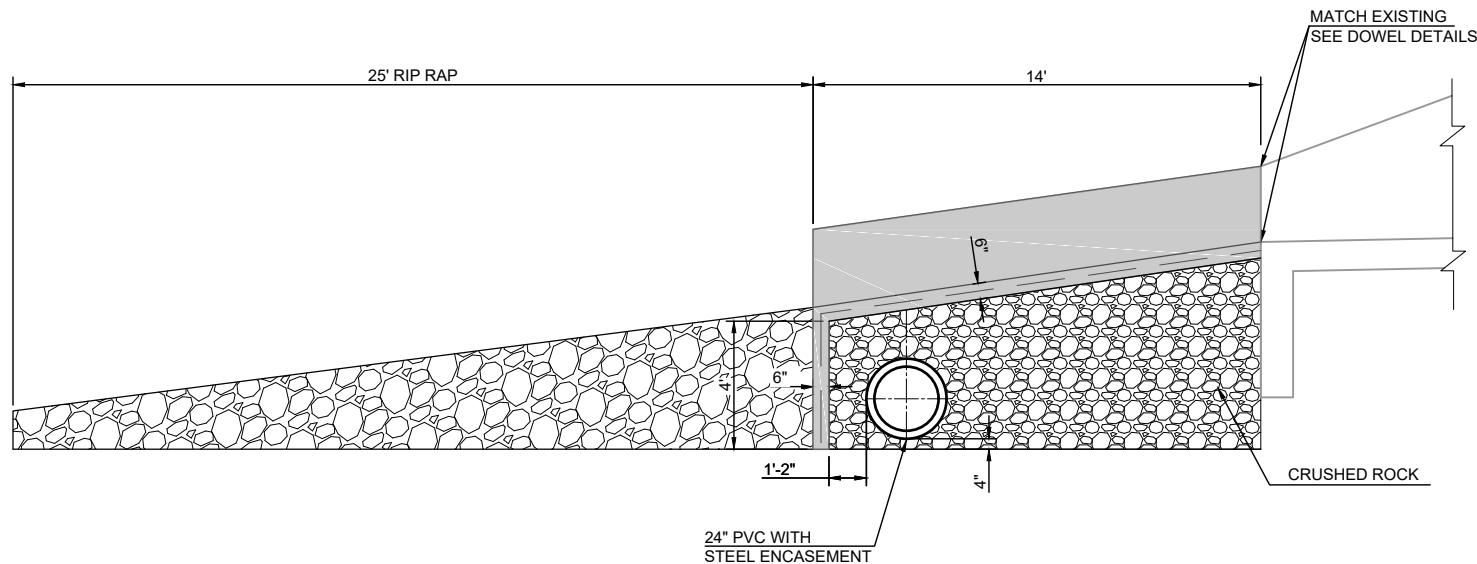

DETAIL 1

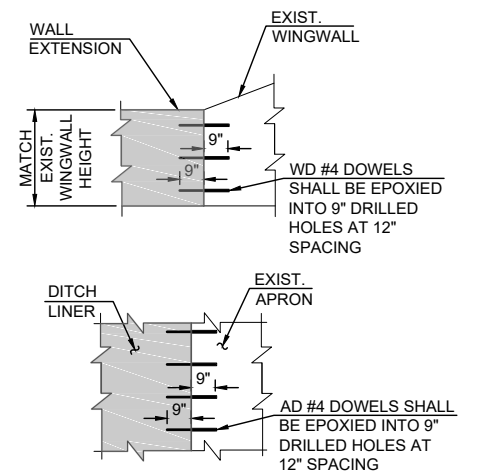

DOWEL DETAILS

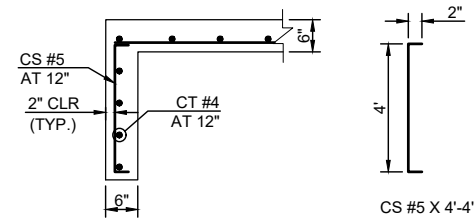

TYPICAL SECTION THRU CURTAIN WALL

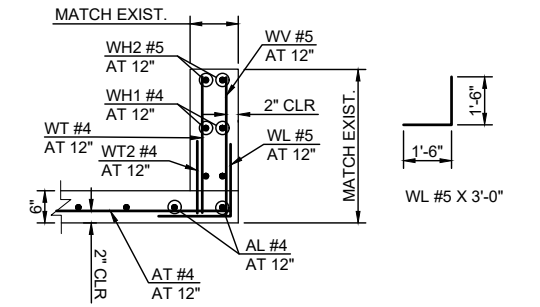

TYPICAL SECTION THRU WALL

BAR LIST					
MARK	No.	SIZE	FORM	LENGTH	REMARKS
AL	59	# 4	STR.	13'-8"	
AT	15	# 4	STR.	58'-2"	
CT	4	# 4	STR.	58'-2"	
CS	59	# 5	BENT	4'-4"	
WH1	8	# 4	STR.	13'-8"	
WH2	4	# 5	STR.	13'-8"	
WL	30	# 5	BENT	3'-0"	
WT	30	# 4	STR.	3'-2"	
WV	30	# 5	STR.	3'-2"	
AD	59	# 4	STR.	1'-6"	
WD	6	# 4	STR.	1'-6"	

COUNT FOR WH1 BARS AND LENGTH OF WV & WT BARS IS BASED ON ESTIMATED 3'-0" WALL HEIGHT.

GENERAL CHANNEL REPLACEMENT NOTES:

1. MATCH EXISTING JOINT LAYOUT
2. MATCH ALL EXPANSION JOINT LOCATIONS
3. A MINIMUM OF 12" CRUSHED ROCK BASE SHALL BE INSTALLED. ANY OVER-EXCAVATION SHALL BE FILLED WITH COMPACTED CRUSHED ROCK AT THE CONTRACTORS EXPENSE.
4. THE COMPACTED CRUSHED ROCK AGGREGATE BASE, PLACED TO THE NEAT LINES SHOWN, SHALL NOT BE PAID FOR SEPARATELY, BUT SHALL BE INCLUDED IN THE UNIT PRICE BID PER SQUARE YARD OF CONCRETE CHANNEL LINER. ANY OVER-EXCAVATION SHALL BE BROUGHT TO GRADE WITH COMPACTED CRUSHED ROCK AGGREGATE AT THE CONTRACTORS EXPENSE.
5. ANY PLACEMENT OF CRUSHED ROCK OR GEOTEXTILE TO MODIFY THE SUBGRADE DUE TO POOR SOIL CONDITIONS MUST BE APPROVED BY THE ENGINEER IN WRITING PRIOR TO THE PLACEMENT OF THE CRUSHED ROCK OR GEOTEXTILE. ANY SUCH WORK BY THE CONTRACTOR WITHOUT PRIOR WRITTEN APPROVAL SHALL BE AT HIS OWN EXPENSE.
6. CRUSHED ROCK TO BE COMPACTED TO 95% STD. DENSITY FOR THE ENTIRE CHANNEL LINER REPLACEMENT AREA.
7. ALL NEW CHANNEL LINER SHALL BE TIED BACK TO EXISTING APRON WITH #4 BAR DOWELS SPACED AT 12" CENTER TO CENTER. 18" DOWELS SHALL BE DRILLED AND EPOXY ANCHORED AT THE MID-SLAB THICKNESS POINTS OF EXISTING CHANNEL LINER.



FILE PATH: Z:\STANDARD DETAILS & WATER METER SPECIFICATIONS\UPDATED STANDARD DETAILS 2014\SEWERWORKING\SANSEW-STD-014-SIGNED.DWG

SANITARY SEWER STANDARD DETAIL DRAWING INDEX

DRAWING INDEX	ISSUE DATE:
S.01 GENERAL CONSTRUCTION NOTES - PAGE 1 OF 2	3/13/2014
S.02 GENERAL CONSTRUCTION NOTES - PAGE 2 OF 2	3/13/2014
S.03 REINFORCED CONCRETE PIPE MINIMUM DESIGN	3/13/2014
S.04 VITRIFIED CLAY PIPE DESIGN	3/13/2014
S.05 MANHOLE TESTING	3/13/2014
S.06 EMBEDMENT MATERIAL & TRENCH WIDTH TABLE	3/13/2014
S.07 BACKFILLING REQUIREMENTS - PAGE 1 OF 2	3/13/2014
S.08 BACKFILLING REQUIREMENTS - PAGE 2 OF 2	3/13/2014
S.09 PIPE INSTALLATION DETAILS	3/13/2014
S.10 REBUILDING MANHOLES STANDARD DETAIL	3/13/2014
S.11 ABANDONING MANHOLES STANDARD DETAIL	3/13/2014
S.12 EMBEDMENT PLUG	3/13/2014
S.13 PRECAST REINFORCED CONCRETE MANHOLE TRANSITION SECTION	3/13/2014
S.14 REINFORCED CONCRETE PRECAST MANHOLE BASE SECTION	3/13/2014
S.15 REINFORCED CONCRETE PRECAST 4 FT DIAMETER MANHOLE CONE	3/13/2014
S.16 PRECAST MANHOLE WALL DETAIL	3/13/2014
S.17 PRECAST REINFORCED CONCRETE FLAT SLAB MANHOLE TOP	3/13/2014
S.18 CAST-IN-PLACE CONCRETE MANHOLE BASE SECTION	3/13/2014
S.19 MANHOLE PIPE CONNECTION FOR CAST IN PLACE MANHOLES	3/13/2014
S.20 MANHOLE LID / RING GENERAL NOTES	3/13/2014
S.21 REVERSIBLE MANHOLE RING	3/13/2014
S.22 VENTED MANHOLE COVER - PAGE 1 OF 2	3/13/2014
S.23 VENTED MANHOLE COVER - PAGE 2 OF 2	3/13/2014
S.24 NON-VENTED MANHOLE COVER - PAGE 1 OF 2	3/13/2014
S.25 NON-VENTED MANHOLE COVER - PAGE 2 OF 2	3/13/2014
S.26 SERVICE CONNECTION INSTALLATION	3/13/2014
S.27 SERVICE CONNECTION TYPES	3/13/2014
S.28 BORE AND ENCASEMENT DETAIL - PAGE 1 OF 2	3/13/2014
S.29 BORE AND ENCASEMENT DETAIL - PAGE 2 OF 2	3/13/2014
S.30 CONCRETE COLLAR WITH SPREAD FOOTING - PAGE 1 OF 2	3/13/2014
S.31 CONCRETE COLLAR WITH SPREAD FOOTING - PAGE 2 OF 2	3/13/2014
S.32 TYPE I PIER - TYPE 1 OF 2	3/13/2014
S.33 TYPE I PIER - TYPE 2 OF 2	3/13/2014
S.34 TYPE II PIER	3/13/2014
S.35 STEEL CARRIER PIPE SIZES MAXIMUM SPAN LENGTH	3/13/2014

SANITARY SEWER STANDARD DETAIL

- ALL CONSTRUCTION SHALL BE IN ACCORDANCE WITH THE CITY OF OKLAHOMA CITY STANDARD SPECIFICATIONS FOR CONSTRUCTION OF PUBLIC IMPROVEMENTS.
- ALL WORK NOT CLASSIFIED AS A CONTRACT PAY ITEM SHALL BE CONSIDERED AS AN INCIDENTAL AND NOT PAID FOR DIRECTLY.
- ALL EXCAVATION UNDER EXISTING PAVEMENT SHALL BE BACKFILLED WITH CRUSHER RUN ROCK. ALL EXCAVATION UNDER FUTURE PAVEMENT SHALL BE BACKFILLED WITH SAND.
- PIPE LEAKAGE TESTS SHALL BE PERFORMED BY THE CONTRACTOR IN ACCORDANCE WITH THE OKLAHOMA CITY SEWER REQUIREMENTS. LEAKAGE SHALL NOT EXCEED 50 GALLONS PER INCH OF NORMAL PIPE PER MILE PER DAY FOR ANY SECTION OF THE SYSTEM.
- DEFLECTION TESTS SHALL BE PERFORMED ON ALL FLEXIBLE PIPE. THE TEST SHALL BE CONDUCTED AFTER THE FINAL BACKFILL HAS BEEN IN PLACE FOR AT LEAST THIRTY (30) DAYS. NO PIPE SHALL EXCEED A DEFLECTION OF MORE THAN FIVE (5%) PERCENT. IF THE DEFLECTION TEST IS TO BE RUN USING A RIGID BALL AND MANDREL, IT SHALL HAVE A DIAMETER EQUAL TO NINETY-FIVE (95%) PERCENT OF THE INSIDE DIAMETER OF THE PIPE. THE TEST SHALL BE PERFORMED WITHOUT MECHANICAL PULLING DEVICES.
- POLYVINYL CHLORIDE (PVC) PIPES SHALL CONFORM TO ASTM F-794 FOR OPEN PROFILE PIPE AND ASTM F-1803 FOR CLOSED PROFILE PIPE. REGARDLESS OF SIZE, OPEN PROFILE WALL PIPE WILL BE ALLOWED ONLY ON SECTIONS OF PIPE WHERE THERE ARE NO APPARENT SERVICE CONNECTIONS.
- SPECIAL SANITARY SEWER PIPE SHALL BE REQUIRED TO SATISFY MINIMUM HORIZONTAL AND VERTICAL CLEARANCE REQUIREMENTS FROM WATERLINES, WELLS AND PETROLEUM STORAGE TANKS, AS ESTABLISHED BY THE OKLAHOMA STATE DEPARTMENT OF ENVIRONMENTAL QUALITY (ODEQ).
- SPECIAL PVC PIPE SHALL CONFORM TO ASTM D-2241 AND SDR 32.5 FOR SIZES FOUR (4") INCHES TO THIRTY-SIX (36") INCHES, OR AWWA C-900 AND AWWA C-905, WITH A MINIMUM DR RATING OF DR18 FOR PIPE SIZES FOUR (4") INCHES TO TWELVE (12") INCHES AND A MINIMUM DR RATING OF DR32.5 FOR PIPE SIZES GREATER THAN TWELVE (12") INCHES.
- DUCTILE IRON PIPE (DIP) SHALL CONFORM TO THE REQUIREMENTS OF AWWA C-151.
  - EXTERIOR COATING - THE EXTERIOR SURFACES OF DUCTILE IRON PIPE, SPECIFICATIONS AND FITTINGS SHALL BE COATED WITH AN ASPHALTIC COATING IN ACCORDANCE WITH ASTM A746, SECTION 6.1, OF AWWA E-151. THE COATING SHALL HAVE A MINIMUM THICKNESS OF ONE (1) MIL.
  - INTERIOR COATING - INTERIOR SURFACES OF PIPE AND FITTINGS SHALL BE LINED WITH FORTY (40) MILS OF VIRGIN POLYETHYLENE COMPLYING WITH ASTM D-1248 OR MADISON POLYETHYLENE LINING, CORPORATE II TX-5 MINUTE NUMBER 17115, MANUFACTURED BY MADISON CHEMICALS, INC., CANADA, OR APPROVED EQUAL. THE LINING MATERIALS SHALL BE COMPOUNDED WITH A MINIMUM OF TWO (2%) PERCENT CARBON BLACK TO RESIST ULTRA VIOLET RAYS.
  - THICKNESS - UNLESS OTHERWISE SPECIFIED, DUCTILE IRON PIPE SHALL MEET THE REQUIREMENTS IN THE FOLLOWING TABLE AS SHOWN IN DETAIL S-42.

SANITARY SEWER STANDARD DETAIL DIP PIPE THICKNESS REQUIREMENTS

DEPTH OF COVER (FEET)	Standard Pressure (AWWA C-151)	Normal Pressure (AWWA C-151)
>50' or >30'	0.25 3000	0.25 3000
>45' or >25'	0.25 3000	0.25 3000
>40' or >20'	0.25 3000	0.25 3000
>35' or >15'	0.25 3000	0.25 3000
>30' or >10'	0.25 3000	0.25 3000
>25' or >5'	0.25 3000	0.25 3000
>20' or >0'	0.25 3000	0.25 3000
>15' or >-5'	0.25 3000	0.25 3000
>10' or >-10'	0.25 3000	0.25 3000
>5' or >-15'	0.25 3000	0.25 3000
>0' or >-20'	0.25 3000	0.25 3000
>-5' or >-25'	0.25 3000	0.25 3000
>-10' or >-30'	0.25 3000	0.25 3000
>-15' or >-35'	0.25 3000	0.25 3000
>-20' or >-40'	0.25 3000	0.25 3000
>-25' or >-45'	0.25 3000	0.25 3000
>-30' or >-50'	0.25 3000	0.25 3000
>-35' or >-55'	0.25 3000	0.25 3000
>-40' or >-60'	0.25 3000	0.25 3000
>-45' or >-65'	0.25 3000	0.25 3000
>-50' or >-70'	0.25 3000	0.25 3000
>-55' or >-75'	0.25 3000	0.25 3000
>-60' or >-80'	0.25 3000	0.25 3000
>-65' or >-85'	0.25 3000	0.25 3000
>-70' or >-90'	0.25 3000	0.25 3000
>-75' or >-95'	0.25 3000	0.25 3000
>-80' or >-100'	0.25 3000	0.25 3000
>-85' or >-105'	0.25 3000	0.25 3000
>-90' or >-110'	0.25 3000	0.25 3000
>-95' or >-115'	0.25 3000	0.25 3000
>-100' or >-120'	0.25 3000	0.25 3000
>-105' or >-125'	0.25 3000	0.25 3000
>-110' or >-130'	0.25 3000	0.25 3000
>-115' or >-135'	0.25 3000	0.25 3000
>-120' or >-140'	0.25 3000	0.25 3000
>-125' or >-145'	0.25 3000	0.25 3000
>-130' or >-150'	0.25 3000	0.25 3000
>-135' or >-155'	0.25 3000	0.25 3000
>-140' or >-160'	0.25 3000	0.25 3000
>-145' or >-165'	0.25 3000	0.25 3000
>-150' or >-170'	0.25 3000	0.25 3000
>-155' or >-175'	0.25 3000	0.25 3000
>-160' or >-180'	0.25 3000	0.25 3000
>-165' or >-185'	0.25 3000	0.25 3000
>-170' or >-190'	0.25 3000	0.25 3000
>-175' or >-195'	0.25 3000	0.25 3000
>-180' or >-200'	0.25 3000	0.25 3000
>-185' or >-205'	0.25 3000	0.25 3000
>-190' or >-210'	0.25 3000	0.25 3000
>-195' or >-215'	0.25 3000	0.25 3000
>-200' or >-220'	0.25 3000	0.25 3000
>-205' or >-225'	0.25 3000	0.25 3000
>-210' or >-230'	0.25 3000	0.25 3000
>-215' or >-235'	0.25 3000	0.25 3000
>-220' or >-240'	0.25 3000	0.25 3000
>-225' or >-245'	0.25 3000	0.25 3000
>-230' or >-250'	0.25 3000	0.25 3000
>-235' or >-255'	0.25 3000	0.25 3000
>-240' or >-260'	0.25 3000	0.25 3000
>-245' or >-265'	0.25 3000	0.25 3000
>-250' or >-270'	0.25 3000	0.25 3000
>-255' or >-275'	0.25 3000	0.25 3000
>-260' or >-280'	0.25 3000	0.25 3000
>-265' or >-285'	0.25 3000	0.25 3000
>-270' or >-290'	0.25 3000	0.25 3000
>-275' or >-295'	0.25 3000	0.25 3000
>-280' or >-300'	0.25 3000	0.25 3000
>-285' or >-305'	0.25 3000	0.25 3000
>-290' or >-310'	0.25 3000	0.25 3000
>-295' or >-315'	0.25 3000	0.25 3000
>-300' or >-320'	0.25 3000	0.25 3000
>-305' or >-325'	0.25 3000	0.25 3000
>-310' or >-330'	0.25 3000	0.25 3000
>-315' or >-335'	0.25 3000	0.25 3000
>-320' or >-340'	0.25 3000	0.25 3000
>-325' or >-345'	0.25 3000	0.25 3000
>-330' or >-350'	0.25 3000	0.25 3000
>-335' or >-355'	0.25 3000	0.25 3000
>-340' or >-360'	0.25 3000	0.25 3000
>-345' or >-365'	0.25 3000	0.25 3000
>-350' or >-370'	0.25 3000	0.25 3000
>-355' or >-375'	0.25 3000	0.25 3000
>-360' or >-380'	0.25 3000	0.25 3000
>-365' or >-385'	0.25 3000	0.25 3000
>-370' or >-390'	0.25 3000	0.25 3000
>-375' or >-395'	0.25 3000	0.25 3000
>-380' or >-400'	0.25 3000	0.25 3000
>-385' or >-405'	0.25 3000	0.25 3000
>-390' or >-410'	0.25 3000	0.25 3000
>-395' or >-415'	0.25 3000	0.25 3000
>-400' or >-420'	0.25 3000	0.25 3000
>-405' or >-425'	0.25 3000	0.25 3000
>-410' or >-430'	0.25 3000	0.25 3000
>-415' or >-435'	0.25 3000	0.25 3000
>-420' or >-440'	0.25 3000	0.25 3000
>-425' or >-445'	0.25 3000	0.25 3000
>-430' or >-450'	0.25 3000	0.25 3000
>-435' or >-455'	0.25 3000	0.25 3000
>-440' or >-460'	0.25 3000	0.25 3000
>-445' or >-465'	0.25 3000	0.25 3000
>-450' or >-470'	0.25 3000	0.25 3000
>-455' or >-475'	0.25 3000	0.25 3000
>-460' or >-480'	0.25 3000	0.25 3000
>-465' or >-485'	0.25 3000	0.25 3000
>-470' or >-490'	0.25 3000	0.25 3000
>-475' or >-495'	0.25 3000	0.25 3000
>-480' or >-500'	0.25 3000	0.25 3000
>-485' or >-505'	0.25 3000	0.25 3000
>-490' or >-510'	0.25 3000	0.25 3000
>-495' or >-515'	0.25 3000	0.25 3000
>-500' or >-520'	0.25 3000	0.25 3000
>-505' or >-525'	0.25 3000	0.25 3000
>-510' or >-530'	0.25 3000	0.25 3000
>-515' or >-535'	0.25 3000	0.25 3000
>-520' or >-540'	0.25 3000	0.25 3000
>-525' or >-545'	0.25 3000	0.25 3000
>-530' or >-550'	0.25 3000	0.25 3000
>-535' or >-555'	0.25 3000	0.25 3000
>-540' or >-560'	0.25 3000	0.25 3000
>-545' or >-565'	0.25 3000	0.25 3000
>-550' or >-570'	0.25 3000	0.25 3000
>-555' or >-575'	0.25 3000	0.25 3000
>-560' or >-580'	0.25 3000	0.25 3000
>-565' or >-585'	0.25 3000	0.25 3000
>-570' or >-590'	0.25 3000	0.25 3000
>-575' or >-595'	0.25 3000	0.25 3000
>-580' or >-600'	0.25 3000	0.25 3000
>-585' or >-605'	0.25 3000	0.25 3000
>-590' or >-610'	0.25 3000	0.25 3000
>-595' or >-615'	0.25 3000	0.25 3000
>-600' or >-620'	0.25 3000	0.25 3000
>-605' or >-625'	0.25 3000	0.25 3000
>-610' or >-630'	0.25 3000	0.25 3000
>-615' or >-635'	0.25 3000	0.25 3000
>-620' or >-640'	0.25 3000	0.25 3000
>-625' or >-645'	0.25 3000	0.25 3000
>-630' or >-650'	0.25 3000	0.25 3000
>-635' or >-655'	0.25 3000	0.25 3000
>-640' or >-660'	0.25 3000	0.25 3000
>-645' or >-665'	0.25 3000	0.25 3000
>-650' or >-670'	0.25 3000	0.25 3000
>-655' or >-675'	0.25 3000	0.25 3000
>-660' or >-680'	0.25 3000	0.25 3000
>-665' or >-685'	0.25 3000	0.25 3000
>-670' or >-690'	0.25 3000	0.25 3000
>-675' or >-695'	0.25 3000	0.25 3000
>-680' or >-700'	0.25 3000	0.25 3000
>-685' or >-705'	0.25 3000	0.25 3000
>-690' or >-710'	0.25 3000	0.25 3000
>-695' or >-715'	0.25 3000	0.25 3000
>-700' or >-720'	0.25 3000	0.25 3000
>-705' or >-725'	0.25 3000	0.25 3000
>-710' or >-730'	0.25 3000	0.25 3000
>-715' or >-735'	0.25 3000	0.25 3000
>-720' or >-740'	0.25 3000	0.25 3000
>-725' or >-745'	0.25 3000	0.25 3000
>-730' or >-750'	0.25 3000	0.25 3000
>-735' or >-755'	0.25 3000	0.25 3000
>-740' or >-760'	0.25 3000	0.25 3000
>-745' or >-765'	0.25 3000	0.25 3000
>-750' or >-770'	0.25 3000	0.25 3000
>-755' or >-775'	0.25 3000	0.25 3000
>-760' or >-780'	0.25 3000	0.25 3000
>-765' or >-785'	0.25 3000	0.25 3000
>-770' or >-790'	0.25 3000	0.25 3000
>-775' or >-795'	0.25 3000	0.25 3000
>-780' or >-800'	0.25 3000	0.25 3000
>-785' or >-805'	0.25 3000	0.25 3000
>-790' or >-810'	0.25 3000	0.25 3000
>-795' or >-815'	0.25 3000	0.25 3000
>-800' or >-820'	0.25 3000	0.25 3000
>-805' or >-825'	0.25 3000	0.25 3000
>-810' or >-830'	0.25 3000	0.25 3000
>-815' or >-835'	0.25 3000	0.25 3000
>-820' or >-840'	0.25 3000	0.25 3000
>-825' or >-845'	0.25 3000	0.25 3000
>-830' or >-850'	0.25 3000	0.25 3000
>-835' or >-855'	0.25 3000	0.25 3000
>-840' or >-860'	0.25 3000	0.25 3000
>-845' or >-865'	0.25 3000	0.25 3000
>-850' or >-870'	0.25 3000	0.25 3000
>-855' or >-875'	0.25 3000	0.25 3000
>-860' or >-880'	0.25 3000	0.25 3000
>-865' or >-885'	0.25 3000	0.25 3000
>-870' or >-890'	0.25 3000	0.25 3000
>-875' or >-895'	0.25 3000	0.25 3000
>-880' or >-900'	0.25 3000	0.25 3000
>-885' or >-905'	0.25 3000	0.25 3000
>-890' or >-910'	0.25 3000	0.25 3000
>-895' or >-915'	0.25 3000	0.25 3000
>-900' or >-920'	0.25 3000	0.25 3000
>-905' or >-925'	0.25 3000	0.25 3000
>-910' or >-930'	0.25 3000	0.25 3000
>-915' or >-935'	0.25 3000	0.25 3000
>-920' or >-940'	0.25 3000	0.25 3000
>-925' or >-945'	0.25 3000	0.25 3000
>-930' or >-950'	0.25 3000	0.25 3000
>-935' or >-955'	0.25 3000	0.25 3000
>-940' or >-960'	0.25 3000	0.25 300





NO.	DATE	DESCRIPTION

SANITARY SEWER  
STANDARD DETAILS

DATE: 03/14/14  
DRAWN BY: JDS  
CHECKED BY: MWS/EJW

SCALE:  
AS SHOWN

SHEET NUMBER  
S-STD-02

### SANITARY SEWER STANDARD DETAIL

#### ABANDONING MANHOLES STANDARD DETAIL

NOTE: SALVAGED MATERIALS, INCLUDING RING AND COVER SHALL BE DELIVERED TO THE LINE MAINTENANCE DIVISION OF THE WATER AND WASTEWATER UTILITIES DEPARTMENT.

APPROVED BY: [Signature] DATE: 3/14/14 S-11

### SANITARY SEWER STANDARD DETAIL

#### REBUILDING MANHOLES STANDARD DETAIL

NOTES:  
1. CAST-IN-PLACE NON-REINFORCED CONCRETE AND BRICK MANHOLES  
1.1. THE EXISTING CONE AND WALL, IF NECESSARY, SHALL BE REMOVED TO A LEVEL WHICH WILL ALLOW INSTALLATION OF NEW CONE TO THE PROPER GRADE. THE EXPOSED CUT-OFF SURFACES OF THE EXISTING MANHOLE WALL SHALL BE CLEANED BY REMOVING LOOSE MATERIAL AND WETTED PRIOR TO CONSTRUCTION OF CONCRETE PAD. ALL LOOSE BACKFILL AROUND THE MANHOLE WALL SHALL BE REMOVED AND REPLACED WITH COMPACTED CRUSHED ROCK. THE NEW CONCRETE PAD SHALL BE CONSTRUCTED, AND A NEW CONE SHALL BE FORMED OR PLACED TO THE PROPER GRADE USING FIFTEEN THOUSAND (15000 PSI) POUNDS PER SQUARE INCH MORTAR.  
2. PRECAST REINFORCED CONCRETE MANHOLES  
2.1. PRECAST SECTIONS SHALL BE REMOVED TO A LEVEL WHERE THE NEW CONE CAN BE INSTALLED TO THE DESIRED GRADE. INSTALLATION SHALL BE IN ACCORDANCE WITH THE APPROPRIATE STANDARD DETAIL FOR PRECAST MANHOLE CONES. A NEW RUBBER GASKET SHALL BE USED TO SEAL EACH SECTION.

APPROVED BY: [Signature] DATE: 3/14/14 S-10

### SANITARY SEWER STANDARD DETAIL

#### PIPE INSTALLATION DETAILS

APPROVED BY: [Signature] DATE: 3/14/14 S-09

### SANITARY SEWER STANDARD DETAIL

#### 3. COMPACTION METHODS

COMPACTION METHODS MAY VARY DEPENDING ON THE MATERIAL OR AS APPROVED BY THE ENGINEER.

A. COHESIVE MATERIALS  
COMPACTION OF COHESIVE MATERIALS MAY BE OBTAINED BY USE OF IMPACT TYPE EQUIPMENT IN CONFINED AREAS, PNEUMATIC TAMPERS AND ENGINE DRIVEN RAMMERS MAY ALSO BE USED. IN RELATIVELY NARROW TRENCHES, SELF-PROPELLED RAMMERS MAY BE USED. IN WIDE TRENCHES, SHEEPSFOOT ROLLERS MAY BE USED.

B. COHESIONLESS MATERIALS  
COHESIONLESS MATERIALS ARE GRANULAR MATERIALS CLASSIFIED AS NON-PLASTIC. IN GENERAL, VIBRATORY EQUIPMENT MAY BE USED FOR PROPER COMPACTION. IN CONFINED AREAS, VIBRATORY PLATES MAY BE USED. FOR WIDER TRENCHES, VIBRATORY ROLLERS MAY BE USED.

C. FLOODING OR JETTING  
WHEN APPROVED BY THE ENGINEER, MATERIALS MAY ALSO BE COMPACTED OR SETTLED BY FLOODING WHERE ADEQUATE QUANTITIES OF WATER ARE AVAILABLE FROM THE CITY'S WATER SYSTEM, PRIVATELY OWNED PONDS, CREEKS OR OTHER SOURCES LOCATED WITHIN THREE HUNDRED FEET (300') OF THE TRENCH. WATER SHALL BE USED TO PRODUCE A SEMI-FLUID MASS ALONG AND OUT OF THE TRENCH AT STREAM CROSSINGS OR OTHER PLACES OF ABRUPT CHANGES IN GROUND PROFILE. THE CONTRACTOR SHALL MAKE NECESSARY ARRANGEMENTS WITH THE CITY FOR THE PURCHASE OF WATER FROM THE CITY WATER MAINS, AND WITH OWNERS OF WATER PROCURED FROM PRIVATELY OWNED WATER SOURCES. NO ADDITIONAL COMPENSATION SHALL BE ALLOWED TO THE CONTRACTOR FOR SETTLING THE BACKFILL BY JETTING. THE COST OF SUCH WORK SHALL BE INCLUDED IN THE UNIT PRICE BID FOR TRENCH EXCAVATION AND BACKFILL OR OTHER PAY ITEMS THE CONTRACTOR MAY ELECT.

#### 4. COMPACTION REQUIREMENTS

ALL BACKFILL SHALL BE TESTED BY AN APPROVED LABORATORY FOR COMPLIANCE OF THE COMPACTION REQUIREMENTS.

#### 5. SURFACE RESTORATION

UPON COMPLETION OF BACKFILLING PROCEDURES, THE CONTRACTOR SHALL REPLACE ALL SURFACE MATERIALS AND SHALL RESTORE PAVING, CURBING, SIDEWALKS, GUTTERS, SHRUBBERY, FENCES, SOD AND OTHER SURFACES DISTURBED TO A CONDITION EQUAL TO OR BETTER THAN THE CONDITION BEFORE WORK BEGAN.

APPROVED BY: [Signature] DATE: 3/14/14 S-08

### SANITARY SEWER STANDARD DETAIL

#### REINFORCED CONCRETE PRECAST 4 FT DIAMETER MANHOLE CONE

APPROVED BY: [Signature] DATE: 3/14/14 S-15

### SANITARY SEWER STANDARD DETAIL

#### REINFORCED CONCRETE PRECAST MANHOLE BASE SECTION

APPROVED BY: [Signature] DATE: 3/14/14 S-14

### SANITARY SEWER STANDARD DETAIL

#### PRECAST REINFORCED CONCRETE MANHOLE TRANSITION SECTION

APPROVED BY: [Signature] DATE: 3/14/14 S-13

### SANITARY SEWER STANDARD DETAIL

#### EMBEDMENT PLUG

NOTES:  
TWO TYPES OF EMBEDMENT PLUGS MAY BE USED, AT THE CONTRACTORS OPTION, AS FOLLOWS:  
1. CLAY PLUGS  
1.1. THE EMBEDMENT AND BACKFILL MATERIAL SHALL BE SELECT CLAY SEPARATED FROM EXCAVATED MATERIAL AND SHALL BE APPROVED BY THE ENGINEER PRIOR TO PLACEMENT. THIS MATERIAL SHALL BE FREE OF CLODS, CLUMPS, DEBRIS, ORGANIC MATERIAL AND STONES. ALL CLAY PLUG MATERIAL SHALL BE COMPACTED TO A MINIMUM OF NINETY (90%) PERCENT OF STANDARD PROCTOR DENSITY (ASTM D-698) AT PLUS OR MINUS THREE (3%) PERCENT OF OPTIMUM MOISTURE CONTENT.  
2. FLOWABLE FILL PLUGS  
2.1. FLOWABLE FILL PLUGS SHALL CONSIST OF A PORTLAND CEMENT GROUT HAVING A MINIMUM TWENTY-EIGHT (28) DAY COMPRESSIVE STRENGTH OF FIVE HUNDRED (500 PSI) POUNDS PER SQUARE INCH.

APPROVED BY: [Signature] DATE: 3/14/14 S-12

PLotted: Friday, March 28, 2014 3:10:47 PM  
FILE PATH: Z:\STANDARD DETAILS & WATER METER SPECIFICATIONS\UPDATED STANDARD DETAILS 2014\SEWERWORKING\SAN-SEW-STD-02-14-SIGNED.DWG















# City of Moore

## Oklahoma

301 N. Broadway, Moore, OK 73160 | (405) 793-5000 | [www.cityofmoore.com](http://www.cityofmoore.com)

### MEMO

**Date:** June 21, 2017  
**To:** File: I-03-W-LMA, Little River Sewer Sanitary Sewer Interceptor  
**From:** Kahley Gilbert, Administrative Assistant *KG*  
**Re:** Budget Change

---

### SUBJECT

Error in budget amount in contract

### EXPLANATION

They City requires the services of Matthews Trenching Company, Inc. ("the Contractor") to complete the Little River Park Sanitary Sewer Interceptor Rehabilitation/Replacement, Project #I-03-W-LMA, not to exceed \$1,271,018.75.

The change in the contract amount is due to a typographical error. All line items budgets will remain the same, however, the total had a typographical error when submitted. The contract amount stated above is the corrected contract amount.

**SAM Search Results**  
**List of records matching your search for :**  
**Record Status: Active**  
**DUNS Number: 007461783**  
**Functional Area: Entity Management, Performance Information**

**No Search Results**

**SAM Search Results**  
**List of records matching your search for :**

**Search Term : matthews\* trenching\***  
**Record Status: Active**

**No Search Results**









# CERTIFICATE OF LIABILITY INSURANCE

DATE (MM/DD/YYYY)  
04/17/2017

THIS CERTIFICATE IS ISSUED AS A MATTER OF INFORMATION ONLY AND CONFERS NO RIGHTS UPON THE CERTIFICATE HOLDER. THIS CERTIFICATE DOES NOT AFFIRMATIVELY OR NEGATIVELY AMEND, EXTEND OR ALTER THE COVERAGE AFFORDED BY THE POLICIES BELOW. THIS CERTIFICATE OF INSURANCE DOES NOT CONSTITUTE A CONTRACT BETWEEN THE ISSUING INSURER(S), AUTHORIZED REPRESENTATIVE OR PRODUCER, AND THE CERTIFICATE HOLDER.

**IMPORTANT:** If the certificate holder is an ADDITIONAL INSURED, the policy(ies) must have ADDITIONAL INSURED provisions or be endorsed. If SUBROGATION IS WAIVED, subject to the terms and conditions of the policy, certain policies may require an endorsement. A statement on this certificate does not confer rights to the certificate holder in lieu of such endorsement(s).

<b>PRODUCER</b> Howell-Stone Insurance, Inc. P.O. Box 5010 Edmond, OK 73083	<b>CONTACT NAME:</b> Shelia J. Schwarz <b>PHONE (A/C, No, Ext):</b> <b>E-MAIL ADDRESS:</b> shelia@howell-stone.com	<b>FAX (A/C, No):</b>
	<b>INSURER(S) AFFORDING COVERAGE</b>	
<b>INSURED</b>  Matthews Trenching Co., Inc. P. O. Box 15479 Oklahoma City, OK 73155	<b>INSURER A :</b> BITCO General Insurance Corp	<b>NAIC #</b> 20095
	<b>INSURER B :</b> BITCO National Insurance Co	20109
	<b>INSURER C :</b> Great American Insurance Group	16691
	<b>INSURER D :</b>	
	<b>INSURER E :</b>	
<b>INSURER F :</b>		

**COVERAGES**                      **CERTIFICATE NUMBER:**                      **REVISION NUMBER:**

THIS IS TO CERTIFY THAT THE POLICIES OF INSURANCE LISTED BELOW HAVE BEEN ISSUED TO THE INSURED NAMED ABOVE FOR THE POLICY PERIOD INDICATED. NOTWITHSTANDING ANY REQUIREMENT, TERM OR CONDITION OF ANY CONTRACT OR OTHER DOCUMENT WITH RESPECT TO WHICH THIS CERTIFICATE MAY BE ISSUED OR MAY PERTAIN, THE INSURANCE AFFORDED BY THE POLICIES DESCRIBED HEREIN IS SUBJECT TO ALL THE TERMS, EXCLUSIONS AND CONDITIONS OF SUCH POLICIES. LIMITS SHOWN MAY HAVE BEEN REDUCED BY PAID CLAIMS.

INSR LTR	TYPE OF INSURANCE	ADDL INSD	SUBR WVD	POLICY NUMBER	POLICY EFF (MM/DD/YYYY)	POLICY EXP (MM/DD/YYYY)	LIMITS	
A	<input checked="" type="checkbox"/> COMMERCIAL GENERAL LIABILITY <input type="checkbox"/> CLAIMS-MADE <input checked="" type="checkbox"/> OCCUR  GEN'L AGGREGATE LIMIT APPLIES PER: <input type="checkbox"/> POLICY <input checked="" type="checkbox"/> PROJECT <input type="checkbox"/> LOC <input checked="" type="checkbox"/> OTHER: PD Ded: \$2,000	X	X	CLP3651896	04/01/2017	04/01/2018	EACH OCCURRENCE	\$ 1,000,000
							DAMAGE TO RENTED PREMISES (Ea occurrence)	\$ 100,000
							MED EXP (Any one person)	\$ 5,000
							PERSONAL & ADV INJURY	\$ 1,000,000
							GENERAL AGGREGATE	\$ 2,000,000
							PRODUCTS - COMP/OP AGG	\$ 2,000,000
A	<input checked="" type="checkbox"/> AUTOMOBILE LIABILITY <input checked="" type="checkbox"/> ANY AUTO OWNED AUTOS ONLY <input type="checkbox"/> SCHEDULED AUTOS <input checked="" type="checkbox"/> HIRED AUTOS ONLY <input checked="" type="checkbox"/> NON-OWNED AUTOS ONLY	X	X	CAP3651897	04/01/2017	04/01/2018	COMBINED SINGLE LIMIT (Ea accident)	\$ 1,000,000
							BODILY INJURY (Per person)	\$
							BODILY INJURY (Per accident)	\$
							PROPERTY DAMAGE (Per accident)	\$
A	<input checked="" type="checkbox"/> UMBRELLA LIAB <input checked="" type="checkbox"/> OCCUR <input type="checkbox"/> EXCESS LIAB <input type="checkbox"/> CLAIMS-MADE DED <input checked="" type="checkbox"/> RETENTION \$ 10,000	X	X	CUP2811716	04/01/2017	04/01/2018	EACH OCCURRENCE	\$ 2,000,000
							AGGREGATE	\$
							<b>FOLLOW FORM COV</b>	\$
B	<input checked="" type="checkbox"/> WORKERS COMPENSATION AND EMPLOYERS' LIABILITY ANY PROPRIETOR/PARTNER/EXECUTIVE OFFICER/MEMBER EXCLUDED? (Mandatory in NH) <input type="checkbox"/> Y/N If yes, describe under DESCRIPTION OF OPERATIONS below		N/A	WC3651888	04/01/2017	04/01/2018	<input checked="" type="checkbox"/> PER STATUTE <input type="checkbox"/> OTHER	\$ 1,000,000
							E.L. EACH ACCIDENT	\$ 1,000,000
							E.L. DISEASE - EA EMPLOYEE	\$ 1,000,000
							E.L. DISEASE - POLICY LIMIT	\$ 3,000,000
C	Commercial Umbrella			TUE 1110711-01	04/01/2017	04/01/2018	EXCESS OF \$2,000,000	

DESCRIPTION OF OPERATIONS / LOCATIONS / VEHICLES (ACORD 101, Additional Remarks Schedule, may be attached if more space is required)  
 Project #1-03-W-LMA Little River Park Sanitary Sewer Interceptor Rehabilitation/Replacement  
**WHEN REQUIRED BY WRITTEN CONTRACT THAT IS EXECUTED PRIOR TO LOSS**  
 ALL policies include Waiver of Subrogation in Favor of; and General Liability, Auto & Umbrella policies include Additional Insureds of: The City of Moore, Moore Public Works Authority and The Architect (Cabbiness Engineering, 333 12th Ave, SE, Ste 200, Norman, OK 73071

<b>CERTIFICATE HOLDER</b>  City of Moore 301 N. Broadway Moore, OK 73160	<b>CANCELLATION</b>  SHOULD ANY OF THE ABOVE DESCRIBED POLICIES BE CANCELLED BEFORE THE EXPIRATION DATE THEREOF, NOTICE WILL BE DELIVERED IN ACCORDANCE WITH THE POLICY PROVISIONS.
	AUTHORIZED REPRESENTATIVE 